

Nikon

DIGITAL CAMERA

COOLPIX A900

Reference Manual

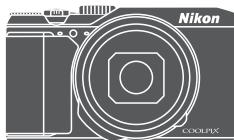

Quick Topic Search

-
- Read this manual thoroughly before using the camera.
 - To ensure proper use of the camera, be sure to read "For Your Safety" (page vi).
 - After reading this manual, keep it in a readily accessible place for future reference.

En

Quick Topic Search

You can return to this page by tapping or clicking  in the lower right of any page.

Main Topics

Introduction	iii
Table of Contents	ix
Parts of the Camera	1
Preparing for Shooting.....	8
Basic Shooting and Playback Operations.....	16
Connecting to a Smart Device (SnapBridge).....	23
Shooting Features.....	32
Playback Features.....	75
Movies	87
Connecting the Camera to a TV, Printer, or Computer.....	101
Using the Menu.....	111
Technical Notes.....	159

Common Topics



For Your Safety



Connecting to a
Smart Device



Tips for Setting
Exposure



Continuous



Editing Images
(Still Images)



Functions That
Cannot Be Used
Simultaneously



Troubleshooting



Index



Introduction

Read This First

Thank you for purchasing the Nikon COOLPIX A900 digital camera.

Symbols and Conventions Used in This Manual

- Tap or click  in the lower right of each page to display “Quick Topic Search” (ii).
- Symbols

Symbol	Description
	This icon marks cautions and information that should be read before using the camera.
	This icon marks notes and information that should be read before using the camera.
	This icon marks other pages containing relevant information.

- SD, SDHC, and SDXC memory cards are referred to as “memory cards” in this manual.
- Smartphones and tablets are referred to as “smart devices.”
- The setting at the time of purchase is referred to as the “default setting.”
- The names of menu items displayed on the camera screen, and the names of buttons or messages displayed on a computer screen appear in bold.
- In this manual, images are sometimes omitted from screen display samples so that screen indicators can be more clearly shown.



Information and Precautions

Life-Long Learning

As part of Nikon's "Life-Long Learning" commitment to ongoing product support and education, continually updated information is available online at the following websites:

- For users in the U.S.A.: <http://www.nikonusa.com/>
- For users in Europe: <http://www.europe-nikon.com/support/>
- For users in Asia, Oceania, the Middle East, and Africa: <http://www.nikon-asia.com/>

Visit these websites to keep up-to-date with the latest product information, tips, answers to frequently asked questions (FAQs), and general advice on digital imaging and photography. Additional information may be available from the Nikon representative in your area. Visit the website below for contact information.

<http://imaging.nikon.com/>

Use Only Nikon Brand Electronic Accessories

Nikon COOLPIX cameras are designed to the highest standards and include complex electronic circuitry. Only Nikon brand electronic accessories (including battery chargers, batteries, AC adapters, and USB cables) certified by Nikon specifically for use with this Nikon digital camera are engineered and proven to operate within the operational and safety requirements of this electronic circuitry.

THE USE OF NON-NIKON ELECTRONIC ACCESSORIES COULD DAMAGE THE CAMERA AND MAY VOID YOUR NIKON WARRANTY.

The use of third-party rechargeable Li-ion batteries not bearing the Nikon holographic seal could interfere with normal operation of the camera or result in the batteries overheating, igniting, rupturing, or leaking.

Holographic seal: Identifies this device as an authentic Nikon product.



For more information about Nikon brand accessories, contact a local authorized Nikon dealer.

Before Taking Important Pictures

Before taking pictures on important occasions (such as at weddings or before taking the camera on a trip), take a test shot to ensure that the camera is functioning normally. Nikon will not be held liable for damages or lost profits that may result from product malfunction.



About the Manuals

- No part of the manuals included with this product may be reproduced, transmitted, transcribed, stored in a retrieval system, or translated into any language in any form, by any means, without Nikon's prior written permission.
- Illustrations and screen content shown in this manual may differ from the actual product.
- Nikon reserves the right to change the specifications of the hardware and software described in these manuals at any time and without prior notice.
- Nikon will not be held liable for any damages resulting from the use of this product.
- While every effort was made to ensure that the information in these manuals is accurate and complete, we would appreciate it were you to bring any errors or omissions to the attention of the Nikon representative in your area (address provided separately).

Comply with Copyright Notices

Under copyright law, photographs or recordings of copyrighted works made with the camera can not be used without the permission of the copyright holder. Exceptions apply to personal use, but note that even personal use may be restricted in the case of photographs or recordings of exhibits or live performances.

Disposing of Data Storage Devices

Please note that deleting images or formatting data storage devices such as memory cards or built-in camera memory does not completely erase the original image data. Deleted files can sometimes be recovered from discarded storage devices using commercially available software, potentially resulting in the malicious use of personal image data. Ensuring the privacy of such data is the user's responsibility.

Before discarding a data storage device or transferring ownership to another person, make sure to format the camera's settings in **Reset all** (📖117) in the setup menu. After formatting the camera's settings, erase all data in the device using commercial deletion software, or format the device in **Format memory** or **Format card** in the setup menu (📖112), then completely refill it with images containing no private information (for example, images of empty sky). Care should be taken to avoid injury or damage to property when physically destroying memory cards.

Conformity Marking

Follow the procedure below to display some of the conformity markings that the camera complies with.

Press the **MENU** button → **Y** menu icon → Conformity marking → **OK** button



For Your Safety

To prevent damage to property or injury to yourself or to others, read "For Your Safety" in its entirety before using this product.

Keep these safety instructions where all those who use this product will read them.



DANGER

Failure to observe the precautions marked with this icon carries a high risk of death or severe injury.



WARNING

Failure to observe the precautions marked with this icon could result in death or severe injury.



CAUTION

Failure to observe the precautions marked with this icon could result in injury or property damage.



WARNING

- Do not use while walking or operating a motor vehicle. Failure to observe this precaution could result in accidents or other injury.
- Do not disassemble or modify this product. Do not touch internal parts that become exposed as the result of a fall or other accident. Failure to observe these precautions could result in electric shock or other injury.
- Should you notice any abnormalities such as the product producing smoke, heat, or unusual odors, immediately disconnect the battery or power source. Continued operation could result in fire, burns or other injury.
- Keep dry. Do not handle with wet hands. Do not handle the plug with wet hands. Failure to observe these precautions could result in fire or electric shock.
- Do not let your skin remain in prolonged contact with this product while it is on or plugged in. Failure to observe this precaution could result in low-temperature burns.
- Do not use this product in the presence of flammable dust or gas such as propane, gasoline or aerosols. Failure to observe this precaution could result in explosion or fire.
- Do not aim the flash at the operator of a motor vehicle. Failure to observe this precaution could result in accidents.



- Keep this product out of reach of children. Failure to observe this precaution could result in injury or product malfunction. In addition, note that small parts constitute a choking hazard. Should a child swallow any part of this product, seek immediate medical attention.
- Do not entangle, wrap or twist the strap around your neck. Failure to observe this precaution could result in accidents.
- Do not use batteries/chargers/AC adapters/USB cables not specifically designated for use with this product. When using batteries/chargers/AC adapters/USB cables designated for use with this product, do not:
 - Damage, modify, forcibly tug or bend the cords or cables, place them under heavy objects, or expose them to heat or flame.
 - Use travel converters or adapters designed to convert from one voltage to another or with DC-to-AC inverters.Failure to observe these precautions could result in fire or electric shock.
- Do not handle the plug when charging the product or using the AC adapter during thunderstorms. Failure to observe this precaution could result in electric shock.
- Do not handle with bare hands in locations exposed to extremely high or low temperatures. Failure to observe this precaution could result in burns or frostbite.



CAUTION

- Do not leave the lens pointed at the sun or other strong light sources. Light focused by the lens could cause fire or damage to product's internal parts. When shooting backlit subjects, keep the sun well out of the frame.
- Turn this product off when its use is prohibited. Disable wireless features when the use of wireless equipment is prohibited. The radio-frequency emissions produced by this product could interfere with equipment onboard aircraft or in hospitals or other medical facilities.
- Remove the battery and disconnect the AC adapter if this product will not be used for an extended period. Failure to observe this precaution could result in fire or product malfunction.
- Do not touch moving parts of the lens or other moving parts. Failure to observe this precaution could result in injury.
- Do not fire the flash in contact with or in close proximity to the skin or objects. Failure to observe this precaution could result in burns or fire.



- Do not leave this product where it will be exposed to extremely high temperatures, for an extended period such as in an enclosed automobile or in direct sunlight. Failure to observe this precaution could result in fire or product malfunction.
-



DANGER for Batteries

- Do not mishandle batteries. Failure to observe the following precautions could result in the batteries leaking, overheating, rupturing, or catching fire:
 - Use only batteries approved for use in this product.
 - Do not expose batteries to flame or excessive heat.
 - Do not disassemble.
 - Do not short circuit the terminals by touching them to necklaces, hairpins, or other metal objects.
 - Do not expose batteries or the products in which they are inserted to powerful physical shocks.
 - Do not attempt to recharge EN-EL12 rechargeable batteries using chargers/cameras not specifically designated for this purpose. Failure to observe this precaution could result in the batteries leaking, overheating, rupturing, or catching fire.
 - If battery liquid comes into contact with the eyes, rinse with plenty of clean water and seek immediate medical attention. Delaying action could result in eye injuries.
-



WARNING for Batteries

- Keep batteries out of reach of children. Should a child swallow a battery, seek immediate medical attention.
 - Do not immerse this product in water or expose to rain. Failure to observe this precaution could result in fire or product malfunction. Immediately dry the product with a towel or similar object should it become wet.
 - Discontinue use immediately should you notice any changes in the batteries, such as discoloration or deformation. Cease charging EN-EL12 rechargeable batteries if they do not charge in the specified period of time. Failure to observe this precaution could result in the batteries leaking, overheating, rupturing, or catching fire.
 - Prior to disposal, insulate battery terminals with tape. Overheating, rupture, or fire may result should metal objects come into contact with the terminals. Recycle or dispose of batteries in accord with local regulations.
 - If battery liquid comes into contact with skin or clothing, immediately rinse the affected area with plenty of clean water. Failure to observe this precaution could result in skin irritation.
-



Table of Contents

Quick Topic Search	ii
Main Topics.....	ii
Common Topics	ii
Introduction	iii
Read This First.....	iii
Symbols and Conventions Used in This Manual	iii
Information and Precautions.....	iv
For Your Safety	vi
Parts of the Camera	1
The Camera Body.....	2
The Monitor	4
For Shooting.....	4
For Playback.....	6
Preparing for Shooting.....	8
How to Attach the Camera Strap	9
Inserting the Battery and Memory Card.....	10
Removing the Battery or Memory Card.....	10
Memory Cards and Internal Memory.....	10
Charging the Battery	11
Changing the Angle of the Monitor.....	13
Camera Setup.....	14
Basic Shooting and Playback Operations	16
Shooting Images.....	17
Using the Flash	19
Recording Movies	19
Playing Back Images.....	20
Deleting Images	21
The Image Selection Screen for Deletion	22
Connecting to a Smart Device (SnapBridge).....	23
Installing the SnapBridge App.....	24
Connecting the Camera and a Smart Device	25
Disabling or Enabling the Wireless Connection	28
Image Upload and Remote Photography.....	29



Image Upload.....	29
Remote Photography.....	30
If a Dialog Related to Wi-Fi Connections Is Displayed in iOS.....	30
If Images Cannot Be Uploaded Successfully.....	31
<hr/>	
Shooting Features.....	32
Selecting a Shooting Mode.....	33
📷 (Auto) Mode.....	34
Scene Mode (Shooting Suited to the Shooting Conditions).....	35
Tips and Notes About Scene Mode.....	36
Using Skin Softening.....	42
Shooting with Easy Panorama.....	43
Playback with Easy Panorama.....	45
Shooting with Smart Portrait (Enhancing Human Faces When Shooting).....	46
Creative Mode (Applying Effects When Shooting).....	50
P, S, A, and M Modes (Setting the Exposure for Shooting).....	52
Tips for Setting Exposure.....	53
The Control Range of the Shutter Speed (P , S , A , and M Modes).....	55
Setting Shooting Functions with the Multi Selector.....	56
Flash Mode.....	57
Self-timer.....	60
Macro Mode (Taking Close-up Pictures).....	61
Using the Creative Slider.....	62
Exposure Compensation (Adjusting Brightness).....	64
Using the Zoom.....	65
Focusing.....	67
The Shutter-release Button.....	67
Using Target Finding AF.....	67
Using Face Detection.....	68
Subjects Not Suitable for Autofocus.....	69
Focus Lock.....	70
Default Settings (Flash, Self-timer, and Macro Mode).....	71
Functions That Cannot Be Used Simultaneously When Shooting.....	73
<hr/>	
Playback Features.....	75
Playback Zoom.....	76
Thumbnail Playback/Calendar Display.....	77
List by Date Mode.....	78
Viewing and Deleting Images in a Sequence.....	79
Viewing Images in a Sequence.....	79
Deleting Images in a Sequence.....	80
Editing Images (Still Images).....	81



Quick Effects: Changing Hue or Mood	81
Quick Retouch: Enhancing Contrast and Saturation	82
D-Lighting: Enhancing Brightness and Contrast.....	82
Red-eye Correction: Correcting Red-eye When Shooting with the Flash	83
Glamour Retouch: Enhancing Human Faces.....	83
Small Picture: Reducing the Size of an Image	85
Crop: Creating a Cropped Copy.....	86
Movies	87
Basic Operations of Movie Recording and Movie Playback.....	88
Capturing Still Images While Recording Movies	91
Shooting Time-lapse Movies	92
Recording Superlapse Movies.....	94
Short Movie Show Mode (Combining Movie Clips to Create Short Movies)	95
Operations During Movie Playback	98
Editing Movies	99
Extracting Only the Desired Portion of a Movie.....	99
Saving a Frame from a Movie as a Still Image	100
Connecting the Camera to a TV, Printer, or Computer	101
Utilizing Images.....	102
Viewing Images on a TV	103
Printing Images Without a Computer	104
Connecting the Camera to a Printer	104
Printing Images One at a Time	105
Printing Multiple Images	106
Transferring Images to a Computer (ViewNX-i).....	108
Installing ViewNX-i.....	108
Transferring Images to a Computer	108
Using the Menu.....	111
Menu Operations.....	112
The Image Selection Screen	114
Menu Lists	115
The Shooting Menu	115
The Movie Menu.....	115
The Playback Menu	116
The Network Menu	116
The Setup Menu	117
The Shooting Menu (The Common Shooting Options).....	118
Image Quality	118
Image Size.....	119



The Shooting Menu (P, S, A, or M Mode)	120
White Balance (Adjusting Hue).....	120
Metering	122
Continuous Shooting.....	123
ISO Sensitivity	125
AF Area Mode.....	126
Autofocus Mode.....	129
M Exposure Preview.....	129
The Movie Menu	130
Movie Options.....	130
AF Area Mode.....	134
Autofocus Mode.....	135
Movie VR.....	136
Wind Noise Reduction	137
Frame Rate.....	137
The Playback Menu	138
Mark for upload	138
Slide Show	139
Protect.....	140
Rotate Image.....	140
Copy (Copy Between the Memory Card and Internal Memory).....	141
Sequence Display.....	142
The Network Menu	143
Operating the Text Input Keyboard.....	144
The Setup Menu	145
Time Zone and Date	145
Monitor Settings.....	147
Date Stamp	149
Photo VR	150
AF Assist	151
Digital Zoom	151
Sound Settings.....	152
Auto Off.....	152
Format Card/Format Memory.....	153
Language	153
Image Comment	154
Copyright Information	155
Location Data	156
Charge by Computer	157
Reset All.....	158
Conformity Marking.....	158
Firmware Version.....	158



Technical Notes	159
Notices	160
Notes About Wireless Communication Functions	162
Caring for the Product	165
The Camera.....	165
The Battery	166
The Charging AC Adapter.....	167
Memory Cards.....	168
Cleaning and Storage	169
Cleaning	169
Storage.....	169
Error Messages	170
Troubleshooting	173
File Names	183
Optional Accessories	184
Specifications	185
Memory Cards That Can Be Used.....	188
Trademark Information.....	189
Index	191



Parts of the Camera

The Camera Body	2
The Monitor	4



The Camera Body

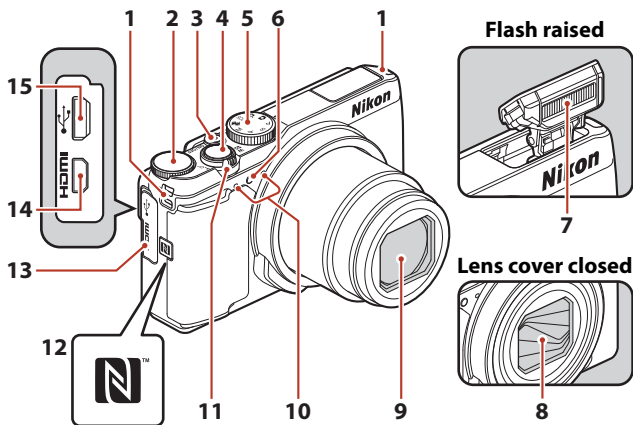

1	Eyelet for camera strap.....	9	Zoom control	18, 65	
2	Command dial.....	52	W : Wide-angle.....	18, 65	
3	Power switch/power-on lamp.....	14	T : Telephoto.....	18, 65	
4	Shutter-release button.....	18, 67	☒ : Thumbnail playback.....	77	
5	Mode dial.....	17, 33	Q : Playback zoom.....	76	
6	Self-timer lamp.....	60	12	N-Mark (NFC antenna).....	25
	AF-assist illuminator.....	117, 151	13	Connector cover.....	11, 102
7	Flash.....	19, 56, 57	14	HDMI micro connector (Type D).....	102
8	Lens cover		15	Micro-USB connector.....	11, 102
9	Lens				
10	Microphone (stereo).....	88			



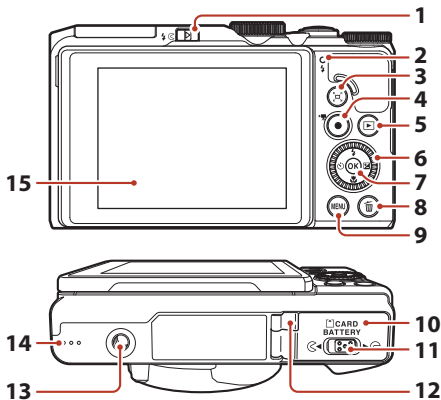

1	(flash pop-up) control	
2	Charge lamp.....	11
	Flash lamp.....	57
3	(snap-back zoom) button	66
4	(movie-record) button	19, 88
5	(playback) button.....	20
6	Rotary multi selector (multi selector)*	52, 56, 112
7	(apply selection) button	112
8	(delete) button	21
9	MENU (menu) button.....	112
10	Battery-chamber/memory card slot cover	10
11	Lock lever	10
12	Power connector cover (for optional AC adapter)	
13	Tripod socket	
14	Speaker	
15	Monitor.....	4, 13

* Also referred to as the "multi selector" in this manual.



The Monitor

The information that is displayed on the shooting or playback screen changes depending on the camera's settings and state of use.

By default, information is displayed when the camera is first turned on and when you operate the camera, and turns off after a few seconds (when **Photo info** is set to **Auto info** in **Monitor settings** (147)).

For Shooting

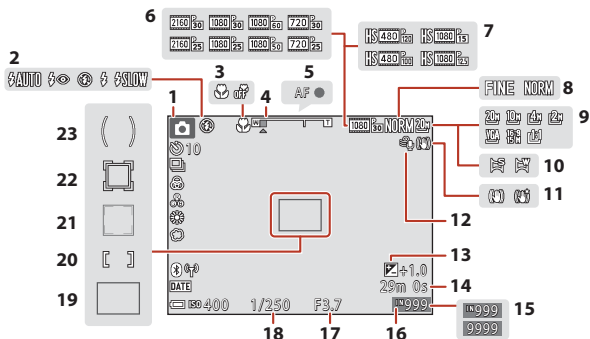

1	Shooting mode.....	33	14	Remaining movie recording time	88, 89
2	Flash mode	56, 57	15	Number of exposures remaining (still images)	17, 118
3	Macro mode.....	56, 61	16	Internal memory indicator.....	17
4	Zoom indicator.....	18, 65	17	F-number.....	52
5	Focus indicator	18	18	Shutter speed.....	52
6	Movie options (normal speed movies).....	115, 130	19	Focus area (target finding AF)	67, 115, 126
7	Movie options (HS movies).....	115, 131	20	Focus area (manual or center)	115, 126
8	Image quality.....	115, 118	21	Focus area (face detection, pet detection)	115, 126
9	Image size.....	115, 119	22	Focus area (subject tracking)	115, 126
10	Easy panorama	35, 43	23	Center-weighted area.....	115, 122
11	Vibration reduction icon	115, 117, 136, 150			
12	Wind noise reduction.....	115, 137			
13	Exposure compensation value.....	62, 64			



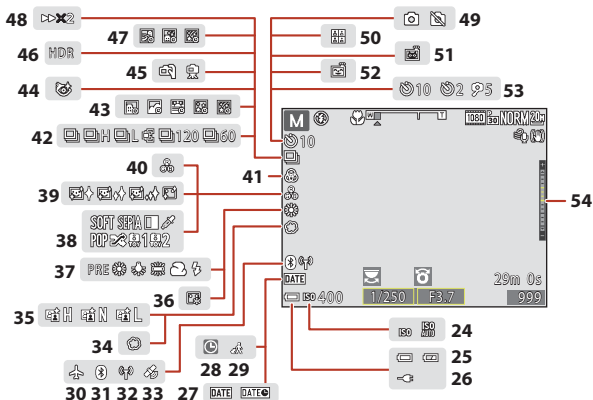

24	ISO sensitivity	115, 125	39	Skin softening	46
25	Battery level indicator	17	40	Hue	46, 62
26	Charging AC Adapter connection indicator		41	Vividness	46, 62
27	Date stamp	117, 149	42	Continuous shooting mode	40, 115, 123
28	"Date not set" indicator	145, 174	43	Time-lapse movie	35, 92
29	Travel destination icon	145	44	Blink proof icon	48
30	Airplane mode	143	45	Hand-held/tripod	37
31	Bluetooth communication indicator	143	46	Backlighting (HDR)	39
32	Wi-Fi communication indicator	143	47	Multiple exposure lighten	41
33	Location data	156	48	Playback speed	
34	Soft	46	49	Still image capture (during movie recording)	91
35	Active D-Lighting	62	50	Self-Collage	47
36	Foundation makeup	46	51	Pet portrait auto release	40, 56, 60
37	White balance mode	115, 120	52	Smile timer	49, 56
38	Special effects	96	53	Self-timer indicator	56, 60
			54	Exposure indicator	54



For Playback

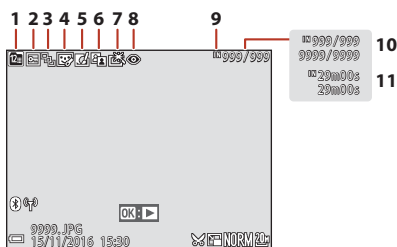

- | | | | | | |
|----------|---|----------|-----------|---|---------|
| 1 | List by date icon..... | 78 | 7 | Quick retouch icon..... | 82, 116 |
| 2 | Protect icon..... | 116, 140 | 8 | Red-eye correction | 83, 116 |
| 3 | Sequence display (when Individual pictures is selected)..... | 116, 142 | 9 | Internal memory indicator | 17 |
| 4 | Glamour retouch icon..... | 83, 116 | 10 | Current image number/total number of images | |
| 5 | Quick effects icon..... | 81, 116 | 11 | Movie length or elapsed playback time | |
| 6 | D-Lighting icon | 82, 116 | | | |



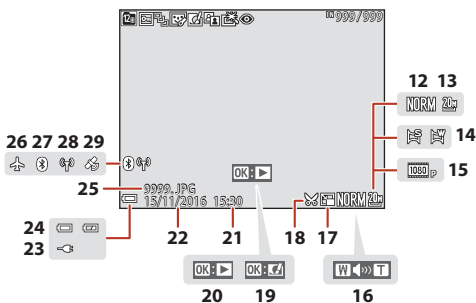

12	Image quality	115, 118	21	Time of recording	
13	Image size	115, 119	22	Date of recording	
14	Easy panorama	35, 43	23	Charging AC Adapter connection indicator	
15	Movie options	115, 130	24	Battery level indicator	17
16	Volume indicator	98	25	File number and type	183
17	Small picture icon	85, 116	26	Airplane mode	143
18	Crop icon	76, 86	27	Bluetooth communication indicator	143
19	Quick effects guide Easy panorama playback guide		28	Wi-Fi communication indicator	143
20	Sequence playback guide Movie playback guide		29	Recorded location data indicator	156



Preparing for Shooting

How to Attach the Camera Strap.....	9
Inserting the Battery and Memory Card.....	10
Charging the Battery.....	11
Changing the Angle of the Monitor	13
Camera Setup.....	14



How to Attach the Camera Strap

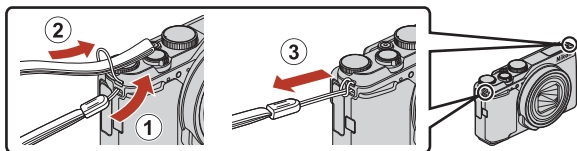

- The camera strap can be attached to the eyelet on either side (left and right) of the camera body.



Inserting the Battery and Memory Card

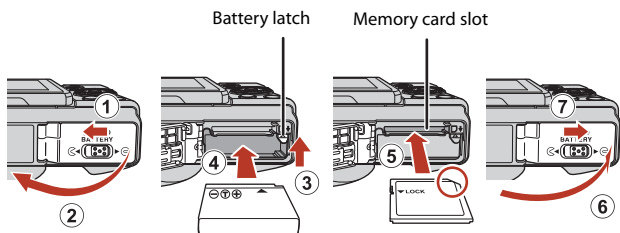

- With the battery's positive and negative terminals oriented correctly, move the orange battery latch (③), and fully insert the battery (④).
- Slide the memory latch until it clicks into place (⑤).
- Be careful not to insert the battery or memory card upside-down or backward, as this could cause a malfunction.

Formatting a Memory Card

The first time you insert a memory card that has been used in another device into this camera, make sure to format it with this camera.

- **Note that formatting a memory card permanently deletes all images and other data on the memory card.** Be sure to make copies of any images you wish to keep before formatting the memory card.
- Insert the memory card into the camera, press the **MENU** button, and select **Format card** in the setup menu (📖112).

Removing the Battery or Memory Card

Turn the camera off and make sure that the power-on lamp and screen have turned off, and then open the battery-chamber/memory card slot cover.

- Move the battery latch to eject the battery.
- Gently push the memory card into the camera to partially eject the memory card.
- Be careful when handling the camera, battery, and memory card immediately after using the camera, as they may be hot.

Memory Cards and Internal Memory

Camera data, including images and movies, can be saved either on a memory card or in the camera's internal memory. To use the camera's internal memory, remove the memory card.



Charging the Battery

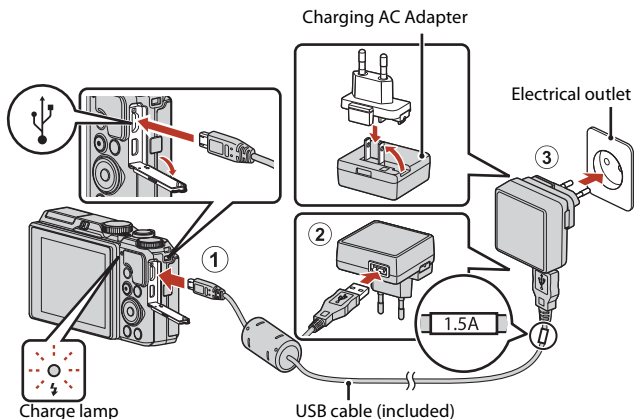

If a plug adapter* is included with your camera, securely connect it to the Charging AC Adapter. Once the two are connected, attempting to forcibly remove the plug adapter could damage the product.

* The shape of the plug adapter varies according to the country or region in which the camera was purchased.

This step can be omitted if the plug adapter comes permanently bonded to the Charging AC Adapter.

- Charging starts when the camera is connected to an electrical outlet while the battery is inserted, as shown in the illustration. The charge lamp slowly flashes green while the battery is charging.
- When charging is complete, the charge lamp turns off. Unplug the Charging AC Adapter from the electrical outlet, and disconnect the USB cable. Charging time is about 2 hours and 20 minutes for a fully exhausted battery.
- The battery cannot be charged when the charge lamp quickly flashes green, possibly due to one of the reasons described below.
 - The ambient temperature is not suited to charging.
 - The USB cable or Charging AC Adapter is not properly connected.
 - The battery is damaged.



Notes About the USB Cable

- Do not use a USB cable other than the UC-E21. Using a USB cable other than the UC-E21 could result in overheating, fire, or electric shock.
- Check the shape and direction of the plugs and do not insert or remove the plugs at an angle.

Notes About Charging the Battery

- The camera can be operated while the battery is charging, but the charging time increases. The charge lamp turns off while the camera is being operated.
- Do not, under any circumstances, use another make or model of AC adapter other than the EH-73P/EH-73PCH Charging AC Adapter, and do not use a commercially available USB-AC adapter or a battery charger for a mobile phone. Failure to observe this precaution could result in overheating or in damage to the camera.



Changing the Angle of the Monitor

You can adjust the direction and angle of the monitor.

For normal shooting



When taking self-portraits

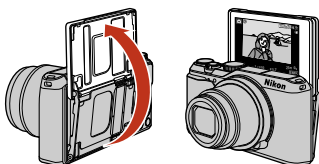

When shooting in a low position

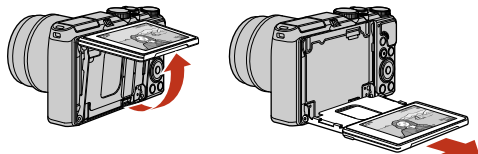

When shooting in a high position

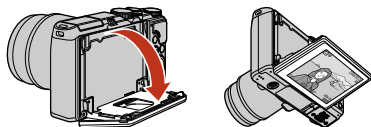

✓ Notes About the Monitor

- When moving the monitor, do not apply excessive force and move slowly within the monitor's adjustable range so that the connection will not be damaged.
- Do not touch the area to the rear of the monitor. Failure to observe this precaution could cause product malfunction.

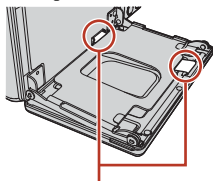

Be particularly careful not to touch these areas.



Camera Setup

1 Turn the camera on.

- Use the multi selector to select and adjust settings.

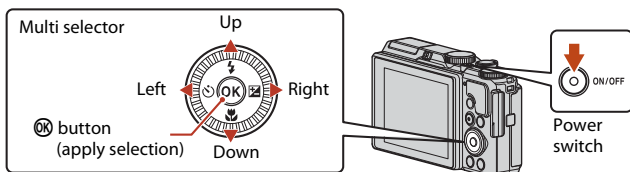

- A language selection dialog will be displayed. Press ▲▼ on the multi selector to highlight a language and press the OK button to select.
- The language can be changed at any time using the **Language** option in the setup menu.
- The power switch is enabled a few seconds after the battery is inserted. Wait a few seconds before pressing the power switch.

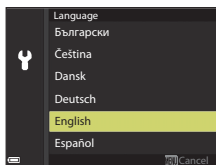

2 When the dialog at right is displayed, follow the instructions below and press the MENU or OK button.

- If you will not establish a wireless connection with a smart device: Press the **MENU** button and proceed to step 3.
- If you will establish a wireless connection with a smart device: Press the **OK** button. See "Connecting to a Smart Device (SnapBridge)" (📖23) for information about the setup procedure.

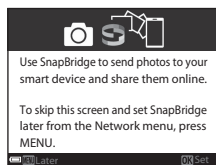

3 When prompted to set the camera clock, press ▲▼ to highlight **Yes** and press the OK button.



4 Highlight your home time zone and press the **OK** button.

- Press ▲ to set daylight saving time. When it is on, the time is one hour earlier and ☀ is displayed at the top of the map. Press ▼ to turn daylight saving time off.

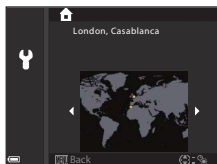

5 Press ▲▼ to select a date format and press the **OK** button.

6 Enter the current date and time and press the **OK** button.

- Press ◀▶ to highlight items and press ▲▼ to change.
- Press the **OK** button to set the clock.

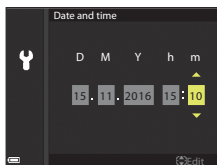

7 When prompted, select **Yes** and press the **OK** button.

- Setup is complete when the camera switches to the shooting screen.
- The time zone and date can be changed at any time using the setup menu (📖145)
→ **Time zone and date.**



Basic Shooting and Playback Operations

Shooting Images.....	17
Playing Back Images.....	20
Deleting Images.....	21





Shooting Images

 (auto) mode is used here as an example.  (auto) mode enables you to perform general shooting in a variety of shooting conditions.

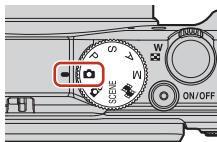
1 Rotate the mode dial to .



Number of exposures remaining

- Battery level indicator
: The battery level is high.
: The battery level is low.
- Number of exposures remaining
 is displayed when no memory card is inserted in the camera, and images are saved in the internal memory.

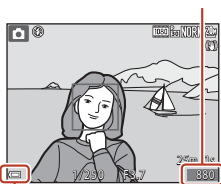

Battery level indicator

2 Hold the camera steady.

- Keep fingers and other objects away from the lens, flash, AF-assist illuminator, microphone, and speaker.
- When taking pictures in portrait ("tall") orientation, turn the camera so that the flash is above the lens.

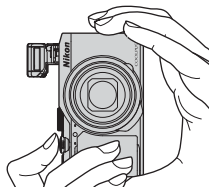

3 Frame the picture.

- Move the zoom control to change the zoom lens position.
- If you lose sight of the subject while shooting with the lens in telephoto position, press the  (snap-back zoom) button to temporarily widen the visible area so that you can frame the subject more easily.

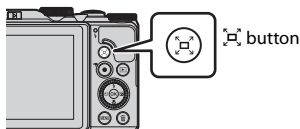
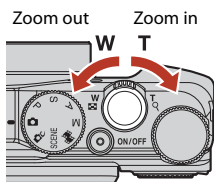

4 Press the shutter-release button halfway.

- To press the shutter-release button “halfway” means to press and hold the button at the point where you feel a slight resistance.
- When the subject is in focus, the focus area or focus indicator is displayed in green.
- When taking self-portraits (, 13), the focus area is not displayed.
- When you are using digital zoom, the camera focuses in the center of the frame and the focus area is not displayed.
- If the focus area or focus indicator flashes, the camera is unable to focus. Modify the composition and try pressing the shutter-release button halfway again.

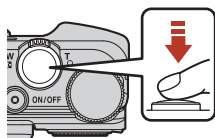

Focus area

5 Without lifting your finger, press the shutter-release button all the way down.





✓ Notes About Saving Images or Movies

The indicator showing the number of exposures remaining or the indicator showing the remaining recording time flashes while images or movies are being saved. **Do not open the battery-chamber/memory card slot cover or remove the battery or memory card** while an indicator is flashing. Doing this could result in loss of data, or in damage to the camera or the memory card.

📎 The Auto Off Function

- When no operations are performed for about one minute, the screen turns off, the camera enters standby mode, and then the power-on lamp flashes. The camera turns off after remaining in standby mode for about three minutes.
- To turn the screen back on while the camera is in standby mode, perform an operation such as pressing the power switch or shutter-release button.

📎 When Using a Tripod

- We recommend using a tripod to stabilize the camera in the following situations:
 - When shooting in dim lighting with the flash mode set to  (off)
 - When the zoom is at a telephoto position
- When using a tripod to stabilize the camera during shooting, set **Photo VR** to **Off** in the setup menu ( 112) to prevent potential errors caused by this function.



Using the Flash

In situations where a flash is needed, such as in dark locations or when the subject is backlit, move the  (flash pop-up) control to raise the flash.

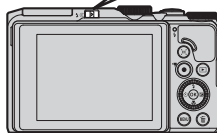
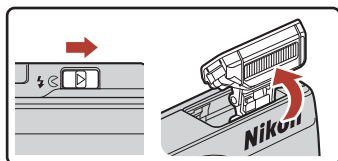
- When not using the flash, gently push to lower the flash until it clicks shut.



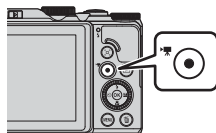

Recording Movies

Display the shooting screen and press the  (movie-record) button to start recording a movie. Press the  button again to end recording.









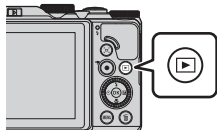

Playing Back Images

1 Press the  (playback) button to enter playback mode.

- If you press and hold down the  button while the camera is turned off, the camera turns on in playback mode.



2 Use the multi selector to select an image to display.

- Press and hold down    to scroll through the images quickly.
- Images can also be selected by rotating the multi selector.
- To play back a recorded movie, press the  button.
- To return to shooting mode, press the  button or shutter-release button.
- When  :  is displayed in full-frame playback mode, you can press the  button to apply an effect to the image.

Display the previous image



Display the next image

- Move the zoom control toward **T**  in full-frame playback mode to zoom in on an image.







- In full-frame playback mode, move the zoom control toward **W**  to switch to thumbnail playback mode and display multiple images on the screen.

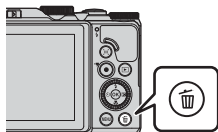

Deleting Images

- 1 Press the  (delete) button to delete the image currently displayed on the screen.



- 2 Use the multi selector   to select the desired deletion method and press the  button.

- To exit without deleting, press the **MENU** button.
- You can also select the desired deletion method by rotating the command dial or multi selector.

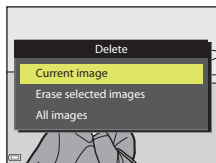

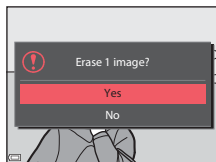

- 3 Select **Yes** and press the  button.

- Deleted images cannot be recovered.



Deleting Images Captured Continuously (Sequence)

- Images captured continuously, or with the multiple exp. lighten, self-collage function, or creative mode, are saved as a sequence, and only one image in the sequence (the key picture) is displayed in playback mode.
- If you press the  button while a key picture is displayed for a sequence of images, all images in the sequence are deleted.
- To delete individual images in a sequence, press the  button to display them one at a time and press the  button.



Deleting the Image Captured While in Shooting Mode

When using shooting mode, press the  button to delete the last image that was saved.



The Image Selection Screen for Deletion

1 Use the multi selector ◀▶ or rotate it to select the image that you want to delete.

- Move the zoom control (📖) toward **T** (🔍) to switch to full-frame playback, or **W** (📐) to switch to thumbnail playback.

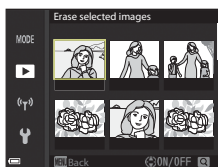

2 Use ▲▼ to select **ON** or **OFF**.

- When **ON** is selected, an icon is displayed under the selected image. Repeat steps 1 and 2 to select additional images.

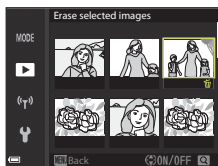

3 Press the **OK** button to apply the image selection.

- A confirmation dialog is displayed. Follow the on-screen instructions to operate.



Connecting to a Smart Device (SnapBridge)

Installing the SnapBridge App.....	24
Connecting the Camera and a Smart Device	25
Image Upload and Remote Photography	29



Installing the SnapBridge App

When you install the SnapBridge app and establish a wireless connection between a SnapBridge-supported camera and smart device, you can upload images captured with the camera to the smart device, or use the smart device to release the camera shutter (📖29).



- Procedures are described using the SnapBridge app Version 2.0. Use the latest version of the SnapBridge app. The operating procedures may vary depending on the camera's firmware, version of the SnapBridge app, or OS of the smart device.
- See the documentation provided with the smart device for information on how to use it.

1 Install the SnapBridge app on the smart device.

- Download the app on the Apple App Store® for iOS, and on Google Play™ for Android™. Search for "snapbridge" and then install it.



- Visit the applicable download site for more information about supported OS versions.
- The "SnapBridge 360/170 app" cannot be used with this camera.

2 Enable Bluetooth and Wi-Fi on the smart device.

- **Use the SnapBridge app to connect to the camera. You cannot connect from the Bluetooth settings screen on the smart device.**

Screens in the SnapBridge App

- ① You can view notices from Nikon and the SnapBridge app Help, as well as configure the app's settings.
- ② Primarily perform connection settings for smart devices and cameras.
- ③ You can view, delete, or share images downloaded from the camera.

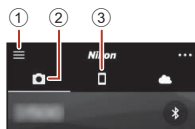

Connecting the Camera and a Smart Device

- Use a sufficiently charged battery so that the camera does not turn off during the procedure.
- Insert a memory card with sufficient free space into the camera.

1 Camera: Select **Network** menu (📖112) → **Connect to smart device**, and press the **OK** button.

- The dialog in step 2 is displayed when you turn on the camera for the first time. This step is unnecessary in such cases.

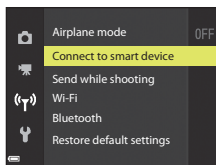

2 Camera: Press the **OK** button when the dialog on the right is displayed.

- A dialog prompting you whether to use the NFC function is displayed. If you will use the NFC function, touch the NFC antenna of the smart device to **N** (N-mark) on the camera. When **Start pairing?** is displayed on the smart device, tap **OK** and proceed to step 6. If you will not use the NFC function, press the **OK** button.

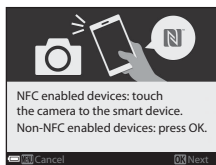
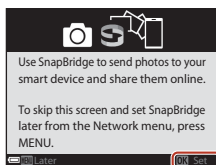

3 Camera: Confirm that the dialog on the right is displayed.

- Prepare the smart device and proceed to the next step.

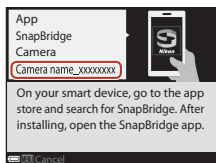

4 Smart device: Launch the SnapBridge app and tap **Pair with camera**.

- When the dialog to select a camera is displayed, tap the camera you want to connect to.
- If you did not connect to the camera by tapping **Skip** at the upper-right of the screen when launching the SnapBridge app for the first time, tap **Pair with camera** in the  tab and proceed to step 5.



5 Smart device: In the **Pair with camera** screen, tap the camera name.

- For iOS, if a dialog explaining the procedure is displayed when connecting, confirm the details and tap **Understood** (if it is not displayed, scroll down the screen). Tap the camera name again when the screen to select an accessory is displayed (it may take some time for the camera name to be displayed).

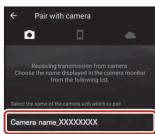

6 Camera/smart device: Confirm that the camera and smart device display the same number (six digits).

- For iOS, the number may not be displayed on the smart device depending on the OS version. Proceed to step 7 in such cases.

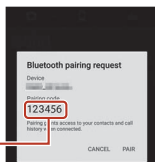
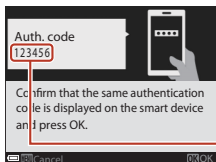

7 Camera/smart device: Press the button on the camera and tap **PAIR** in the SnapBridge app.

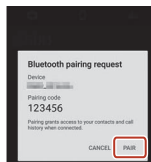



8 Camera/smart device: Finish the connection settings.

Camera: Press the **OK** button when the dialog on the right is displayed.

Smart device: Tap **OK** when the dialog indicating that pairing is complete is displayed.



9 Camera: Follow the on-screen instructions to complete the setup process.

- To record location data with photographs, select **Yes** when prompted and enable the location data features. Enable location data features on the smart device, and in the  tab of the SnapBridge app → **Auto link options** → enable **Synchronize location data**.
- You can synchronize the camera clock to the time reported by the smart device by selecting **Yes** when prompted. In the  tab of the SnapBridge app → **Auto link options** → enable **Synchronize clocks**.

Connecting the camera and smart device is complete.

Still images captured with the camera are automatically uploaded to the smart device.

To Learn More About Using the SnapBridge App

See the online help for details on how to use the SnapBridge app (after connecting, refer to the SnapBridge app menu → **Help**).

<https://nikonimglib.com/snbr/onlinehelp/en/index.html>



If the Connection Is Unsuccessful

- If the camera displays **Could not connect.** when connecting
 - Press the **OK** button and repeat the procedure from step 2 (📖25) in "Connecting the Camera and a Smart Device" to connect again.
 - Press the **MENU** button to cancel the connection.
- The issue may be solved by relaunching the app. Close the SnapBridge app completely and then tap the app icon again to launch it. When the app launches, repeat the procedure from step 1 (📖25) in "Connecting the Camera and a Smart Device".
- If the camera cannot connect and an error occurs in iOS, the camera may be registered as a device in iOS. Launch the iOS settings app and deregister the device (camera name) in such cases.

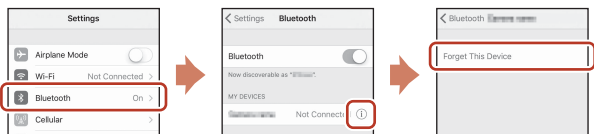

Disabling or Enabling the Wireless Connection

Use any of the following methods to disable or enable the connection.

- Switch the setting in **Network menu** → **Airplane mode** in the camera. You can set it to **On** to turn off all communication functions in places where wireless communication is prohibited.
- Switch the setting in **Network menu** → **Bluetooth** → **Connection** in the camera.
- Switch the setting in the  tab → **Auto link options** → **Auto link** in the SnapBridge app.
You can reduce battery consumption of the smart device by disabling this setting.



Image Upload and Remote Photography

Image Upload

There are three ways to upload images.

- Images in the internal memory cannot be uploaded.



Automatically upload images to the smart device every time they are captured. ^{1,2}	Network menu in the camera → Send while shooting → set Still images to Yes . Movies cannot be uploaded automatically.
Select images in the camera and upload them to the smart device. ^{1,2}	Playback menu in the camera → use Mark for upload to select images. Movies cannot be selected for upload.
Use the smart device to select images in the camera and download them to the smart device.	 tab in the SnapBridge app → tap Download pictures . A dialog related to Wi-Fi connections is displayed. Tap OK ³ and select images.

¹ The size of images that are uploaded is 2 megapixels.

² When **Network menu** → **Bluetooth** → **Send while off** in the camera is set to **On**, images are uploaded to the smart device automatically even when the camera is turned off.

³ Depending on the iOS version, you must select the camera SSID when you tap **OK**. See "If a Dialog Related to Wi-Fi Connections Is Displayed in iOS" (p.30).

Notes About When in a Wi-Fi Connection

- If the smart device enters sleep mode or you switch from the SnapBridge app to another app, the Wi-Fi connection will be disconnected.
- Some functions of the SnapBridge app cannot be used during a Wi-Fi connection. To cancel a Wi-Fi connection, tap the  tab →  → **Yes**.

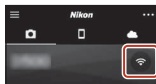

Remote Photography

You can tap the  tab in the SnapBridge app → **Remote photography** to release the camera shutter using a smart device.

- Follow the instructions in the SnapBridge app to switch to a Wi-Fi connection. In iOS, a dialog related to Wi-Fi connections may be displayed. In such cases, see “If a Dialog Related to Wi-Fi Connections Is Displayed in iOS” (📖30).
- You cannot perform remote photography if a memory card is not inserted in the camera.

If a Dialog Related to Wi-Fi Connections Is Displayed in iOS

The SnapBridge app normally connects the camera and smart device via Bluetooth. However, switch to a Wi-Fi connection when using **Download pictures** or remote photography. Depending on the iOS version, you must switch the connection manually. In such cases, use the following procedure to set the connection.

- 1** Write down the camera SSID (camera name at default) and password displayed on the screen in the smart device, and then tap **View options**.

- You can change the SSID or password by using **Network menu** → **Wi-Fi** → **Network settings** in the camera. To protect your privacy, we recommend that you change the password regularly. Disable the wireless connection when changing the password (📖28).





- 2** Select the SSID you wrote down in step 1 from the list of connections.

- When you connect for the first time, input the password you wrote down in step 1 while taking note of uppercase and lowercase characters. Inputting the password is unnecessary after the first time connecting.
- The Wi-Fi connection is complete when ✓ is displayed next to the camera SSID as shown in the screen on the right. Return to the SnapBridge app and operate the app.



If Images Cannot Be Uploaded Successfully

- If the connection is disconnected while uploading images through the **Send while shooting** or **Mark for upload** function in the camera, the connection and image upload may resume when you turn the camera off and then on again.
 - You may be able to upload by canceling the connection and then establishing a connection again. Tap the  tab in the SnapBridge app →  → **Forget camera** → camera whose connection you want to cancel → **Yes*** to cancel the connection, and then follow the instructions in “Connecting the Camera and a Smart Device” (📖25) to establish a connection again.
- * For iOS, a dialog about device registration will be displayed. Launch the iOS settings app and deregister the device (camera name).

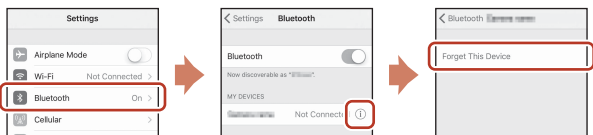

✓ Notes About Image Upload and Remote Photography

- When the camera is being operated, you may be unable to upload images or uploading may be canceled, or you may be unable to perform remote photography using the SnapBridge app.
- When the camera is set to **Multiple exp. Lighten** scene mode, you cannot use the image upload features (**Send while shooting**, **Mark for upload**, or **Download selected pictures**) or **Remote photography**.
Change the settings or switch to playback mode.
When **Bluetooth** → **Send while off** → **On** is set in the network menu, you can resume image upload even after turning off the camera.



Shooting Features

Selecting a Shooting Mode	33
 (Auto) Mode	34
Scene Mode (Shooting Suited to the Shooting Conditions)	35
Creative Mode (Applying Effects When Shooting)	50
P , S , A , and M Modes (Setting the Exposure for Shooting).....	52
Setting Shooting Functions with the Multi Selector	56
Flash Mode.....	57
Self-timer	60
Macro Mode (Taking Close-up Pictures)	61
Using the Creative Slider	62
Exposure Compensation (Adjusting Brightness).....	64
Using the Zoom	65
Focusing	67
Default Settings (Flash, Self-timer, and Macro Mode).....	71
Functions That Cannot Be Used Simultaneously When Shooting	73



Selecting a Shooting Mode

You can rotate the mode dial to align the desired shooting mode with the indicator mark on the camera body.

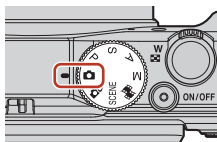

- **📷 (Auto) mode**

Select this mode to perform general shooting in a variety of shooting conditions.

- **📷C (Creative) mode**

The camera saves four images with effects and one image without effects simultaneously in one shot.

- **SCENE (Scene) modes**

Press the **MENU** button and select a scene mode.

- **Scene auto selector:** The camera recognizes the shooting conditions when you frame a picture, and you can take pictures in accordance with the conditions.
- **Time-lapse movie:** The camera can automatically capture still images at a specified interval to create time-lapse movies (**1080 P 30 1080/30p** or **1080 P 25 1080/25p**) that are approximately 10 seconds long.
- **Multiple exp. Lighten:** The camera automatically captures moving subjects at regular intervals, compares each image and composites only their bright areas, and then saves them as one image. Light trails such as the flow of car lights or motion of stars are captured.
- **Superlapse movie:** Use to record movies while moving the camera and record changes in the subject as time elapses. The movies are recorded in fast motion (**1080 P 30 1080/30p** or **1080 P 25 1080/25p**).
- **Smart portrait:** Use glamour retouch to enhance human faces during shooting, and use the smile timer or self-collage function to take pictures.

In addition to the above modes, you can select various scene modes.

- **📷M (Short movie show) mode**

The camera creates a short movie that is up to 30 seconds long (**1080 P 30 1080/30p** or **1080 P 25 1080/25p**) by recording and automatically combining multiple movie clips that are several seconds long.

- **P, S, A, and M modes**

Select these modes for greater control over shutter speed and f-number.

Help Display

The descriptions of functions are displayed while changing the shooting mode or while the setting screen is displayed.

Press the shutter-release button halfway to quickly switch to shooting mode. You can show or hide the descriptions using **Help display** in **Monitor settings** in the setup menu.





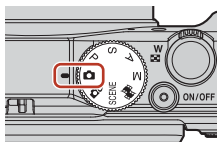

(Auto) Mode

Select this mode to perform general shooting in a variety of shooting conditions.

- The camera detects the main subject and focuses on it (target finding AF). If a human face is detected, the camera automatically sets focus priority on it.
- See "Focusing" ( 67) for more information.



Functions Available in (Auto) Mode

- Flash mode ( 57)
- Self-timer ( 60)
- Macro mode ( 61)
- Exposure compensation ( 64)
- Shooting menu ( 118)



Scene Mode (Shooting Suited to the Shooting Conditions)

Select any one of scene modes based on the shooting conditions, and you can take pictures with the appropriate settings for those conditions.

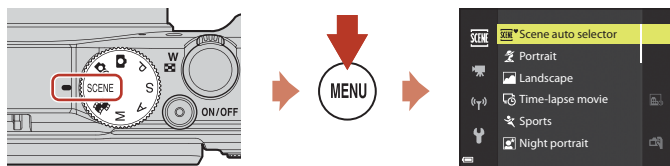

Press the **MENU** button to display the scene menu and select one of the following scene modes using the multi selector.

Scene auto selector (default setting) (📖36)	Night landscape (📖37) ^{1,2}
Portrait	Close-up (📖38)
Landscape ^{1,2}	Food (📖38)
Time-lapse movie (📖92) ²	Fireworks show (📖38) ^{1,3}
Sports (📖36) ¹	Backlighting (📖39) ¹
Night portrait (📖37)	Easy panorama (📖43) ¹
Party/indoor (📖37) ²	Pet portrait (📖40)
Beach ²	Multiple exp. Lighten (📖41) ^{3,4}
Snow ²	Superlapse movie (📖94)
Sunset ^{2,3}	Smart portrait (📖46)
Dusk/dawn ^{1,2,3}	

¹ The camera focuses at infinity.

² The camera focuses on the area in the center of the frame.

³ Use of a tripod is recommended because the shutter speed is slow. Set **Photo VR** (📖150) to **Off** in the setup menu when using a tripod to stabilize the camera during shooting.











⁴ When **Nightscape + light trails** is selected, the camera focuses on the area in the center of the frame. When **Nightscape + star trails** or **Star trails** is selected, the camera focuses at infinity.





Tips and Notes About Scene Mode

SCENE → Scene auto selector

- When you point the camera at the subject, the camera automatically recognizes the shooting conditions and adjusts the shooting settings accordingly.

	Portrait (for taking close-up portraits of one or two people)
	Portrait (for taking portraits of large numbers of people, or images in which the background takes up a large portion of the frame)
	Landscape
	Night portrait (for taking close-up portraits of one or two people)
	Night portrait (for taking portraits of large numbers of people, or images in which the background takes up a large portion of the frame)
	Night landscape
	Close-up
	Backlighting (for taking pictures of subjects other than people)
	Backlighting (for taking portrait pictures)
	Other shooting conditions









- Under some shooting conditions, the camera may not select the desired settings. In this case, select another shooting mode (33).
- If human faces are detected when the picture is taken, the camera softens the facial skin tones using the skin softening function (42).

SCENE → Sports

- While the shutter-release button is held all the way down, images are captured continuously.
- The camera can capture up to about 7 images continuously at a rate of about 7 fps (when set to **Normal** (image quality) and **20p 5184x3888** (image size)).
- The frame rate for continuous shooting may become slow depending on the current image quality setting, image size setting, the memory card used, or shooting conditions.
- Focus, exposure, and hue for the second and subsequent images are fixed at the values determined with the first image.









SCENE → Night portrait

- On the screen displayed when  **Night portrait** is selected, select  **Hand-held** or  **Tripod**.
-  **Hand-held** (default setting):
 - While the  icon on the shooting screen is displayed in green, press the shutter-release button all the way to capture a series of images which are combined into a single image and saved.
 - Once the shutter-release button is pressed all the way, hold the camera still until a still image is displayed. After taking a picture, do not turn the camera off before the screen switches to the shooting screen.
 - If the subject moves while the camera is shooting continuously, the image may be distorted, overlapped, or blurred.
 - The angle of view (i.e., the area visible in the frame) seen in the saved image is narrower than that seen on the shooting screen.
 - Continuous shooting may not be possible in certain shooting conditions.
-  **Tripod**:
 - One image is captured at a slow shutter speed when the shutter-release button is pressed all the way.
 - Vibration reduction is disabled regardless of the **Photo VR** setting (150) in the setup menu.
- The flash always fires. Raise the flash before shooting.
- If human faces are detected when the picture is taken, the camera softens the facial skin tones using the skin softening function (42).

SCENE → Party/indoor

- To avoid the effects of camera shake, hold the camera steady. Set **Photo VR** (150) to **Off** in the setup menu when using a tripod to stabilize the camera during shooting.

SCENE → Night landscape

- On the screen displayed when  **Night landscape** is selected, select  **Hand-held** or  **Tripod**.
-  **Hand-held** (default setting):
 - While the  icon on the shooting screen is displayed in green, press the shutter-release button all the way to capture a series of images which are combined into a single image and saved.
 - Once the shutter-release button is pressed all the way, hold the camera still until a still image is displayed. After taking a picture, do not turn the camera off before the screen switches to the shooting screen.
 - The angle of view (i.e., the area visible in the frame) seen in the saved image is narrower than that seen on the shooting screen.
 - Continuous shooting may not be possible in certain shooting conditions.
-  **Tripod**:
 - One image is captured at a slow shutter speed when the shutter-release button is pressed all the way.
 - Vibration reduction is disabled regardless of the **Photo VR** setting (150) in the setup menu.



SCENE → 📷 Close-up

- Macro mode (📖61) is enabled and the camera automatically zooms to the closest position at which it can focus.
- You can move the focus area. Press the **OK** button, use the multi selector ▲▼◀▶ or rotate it to move the focus area, and press the **OK** button to apply the setting.

SCENE → 🍴 Food

- Macro mode (📖61) is enabled and the camera automatically zooms to the closest position at which it can focus.
- You can adjust hue by using the multi selector ▲▼. The hue setting is saved in the camera's memory even after the camera is turned off.
- You can move the focus area. Press the **OK** button, use the multi selector ▲▼◀▶ or rotate it to move the focus area, and press the **OK** button to apply the setting.





SCENE → 🎆 Fireworks show

- The shutter speed is fixed at 4 seconds.
- The telephoto zoom position is restricted to the angle of view equivalent to that of approx. 300 mm lens (in 35mm [135] format).
- Exposure compensation cannot be used (📖64).



SCENE → Backlighting

- On the screen displayed when  **Backlighting** is selected, select **On** or **Off** to enable or disable the high dynamic range (HDR) function based on the shooting conditions.
- **Off** (default setting): The flash fires to prevent the subject from being hidden in shadow. Shoot images with the flash raised.
 - Press the shutter-release button all the way to capture one image.
- **On**: Use when taking pictures with very bright and dark areas in the same frame.
 - When the shutter-release button is pressed all the way, the camera shoots images continuously at high speed, and saves the following two images.
 - A non-HDR composite image
 - An HDR composite image in which the loss of details in highlights or shadows is minimized
 - If there is only enough memory to save one image, an image processed by D-Lighting (82) at the time of shooting, in which dark areas of the image are corrected, is the only image saved.
 - Once the shutter-release button is pressed all the way, hold the camera still until a still image is displayed. After taking a picture, do not turn the camera off before the screen switches to the shooting screen.
 - The angle of view (i.e., the area visible in the frame) seen in the saved image is narrower than that seen on the shooting screen.
 - Under some shooting conditions, dark shadows may appear around bright subjects or bright areas may appear around dark subjects.

Notes About HDR

Use of a tripod is recommended. Set **Photo VR** (150) in the setup menu to **Off** when using a tripod to stabilize the camera.



SCENE → 🐾 Pet portrait

- When you point the camera at a dog or cat, the camera detects the pet's face and focuses on it. By default, the shutter is automatically released when a dog or cat face is detected (pet portrait auto release).
- On the screen displayed when 🐾 **Pet portrait** is selected, select **[S] Single** or **[📷] Continuous**.
 - **[S] Single**: Whenever a dog or cat face is detected, the camera captures one image.
 - **[📷] Continuous**: Whenever a dog or cat face is detected, the camera captures three images continuously.

✔ **Pet Portrait Auto Release**





- Press the multi selector ◀ (🔊) to change the **Pet portrait auto release** setting.
 - **[📷]**: The camera automatically releases the shutter when it detects a dog or cat face.
 - **OFF**: The camera does not release the shutter automatically, even if a dog or cat face is detected. Press the shutter-release button. The camera also detects human faces when **OFF** is selected.
- **Pet portrait auto release** is set to **OFF** after five bursts have been taken.
- Shooting is also possible by pressing the shutter-release button, regardless of the **Pet portrait auto release** setting.

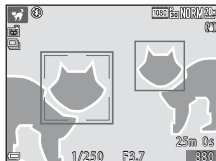

✔ **Focus Area**



- When the camera detects a face, the face is displayed inside a yellow border. When the camera acquires focus on a face displayed inside a double border (focus area), the double border changes to green. If no faces are detected, the camera focuses on the area in the center of the frame.
- Under some shooting conditions, the pet face may not be detected and other subjects may be displayed inside a border.





SCENE → Multiple exp. Lighten

- The camera automatically captures moving subjects at regular intervals, compares each image and composites only their bright areas, and then saves them as one image. Light trails such as the flow of car lights or motion of stars are captured.
- On the screen displayed when  **Multiple exp. Lighten** is selected, select  **Nightscape + light trails**,  **Nightscape + star trails**, or  **Star trails**.

Option	Description
 Nightscape + light trails	Use to capture the flow of car lights against a night landscape background. <ul style="list-style-type: none">• You can rotate the command dial to set the desired interval between the shots. The set interval becomes the shutter speed. When 50 shots are taken, the camera automatically stops shooting.• For every 10 shots taken, one composite image with trails overlapped from the start of shooting is automatically saved.
 Nightscape + star trails	Use to capture the motion of stars with a night landscape in the frame. <ul style="list-style-type: none">• Shots are taken at a shutter speed of 20 seconds every 25 seconds. When 300 shots are taken, the camera automatically stops shooting.• For every 30 shots taken, one composite image with trails overlapped from the start of shooting is automatically saved.
 Star trails	Use to capture the motion of stars. <ul style="list-style-type: none">• Shots are taken at a shutter speed of 25 seconds every 30 seconds. When 300 shots are taken, the camera automatically stops shooting.• For every 30 shots taken, one composite image with trails overlapped from the start of shooting is automatically saved.

- The screen may turn off during the shooting interval. The power-on lamp lights while the screen is off.
- To end shooting before it automatically ends, press the  button.
- When you have obtained the desired trails, end shooting. If you continue shooting, details in the composited areas may be lost.
- The images automatically saved during shooting and the image composited when shooting ends are grouped as a sequence, and the image composited when shooting ends is used as the key picture (79).

Notes About Multiple Exp. Lighten

- The camera cannot capture images when a memory card is not inserted.
- Do not rotate the mode dial or insert a new memory card until shooting ends.
- Use batteries with a sufficient amount of charge remaining to prevent the camera from turning off during shooting.
- Exposure compensation cannot be used (64).
- When using  **Nightscape + star trails** or  **Star trails**, the telephoto zoom position is restricted to the angle of view equivalent to that of approx. 300 mm lens (in 35mm [135] format).



Time Remaining

You can check the time remaining until shooting automatically ends on the screen.

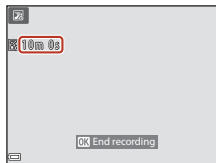

Using Skin Softening

In **Scene auto selector**, **Portrait**, **Night portrait** or **Smart portrait**, if human faces are detected, the camera processes the image to soften facial skin tones before saving the image (up to three faces).

Editing functions such as **Skin softening** can be applied to saved images by using **Glamour retouch** (📖83) even after shooting.



Notes About Skin Softening

- It may take more time than usual to save images after shooting.
- Under some shooting conditions, the desired skin softening results may not be achieved, and skin softening may be applied to areas of the image where there are no faces.



Shooting with Easy Panorama

Rotate the mode dial to **SCENE** → **MENU** button →  Easy panorama →  button

- 1 Select  **Normal** or  **Wide** as the shooting range and press the  button.

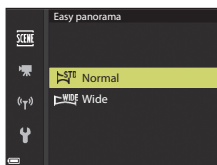



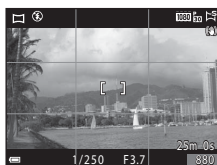

- 2 Frame the first edge of the panorama scene, and then press the shutter-release button halfway to focus.

- The zoom position is fixed at wide-angle.
- The camera focuses in the center of the frame.



- 3 Press the shutter-release button all the way, and then remove your finger from the shutter-release button.

-     are displayed to indicate the direction of camera movement.

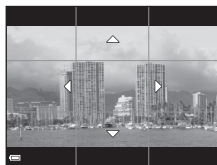

- 4 Move the camera in one of the four directions until the guide indicator reaches the end.

- When the camera detects which direction it is moving in, shooting begins.
- Shooting ends when the camera captures the specified shooting range.
- Focus and exposure are locked until shooting ends.

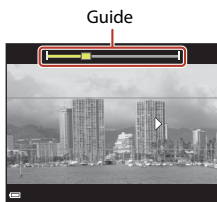

Example of Camera Movement

- Using your body as the axis of rotation, move the camera slowly in an arc, in the direction of the marking ($\triangle \nabla \langle \rangle$).

- Shooting stops if the guide does not reach the edge within about 15 seconds (when STD

Normal is selected) or within about 30 seconds (when WIDE Wide is selected) after shooting starts.



Notes About Easy Panorama Shooting

- The range of the image seen in the saved image is narrower than that seen on the screen at the time of shooting.
- If the camera is moved too quickly or shaken too much, or if the subject is too uniform (e.g. walls or darkness), an error may occur.
- If shooting is stopped before the camera reaches the half-way point in the panorama range, a panorama image is not saved.
- If more than half of the panorama range is captured but shooting ends before reaching the edge of the range, the range not captured is recorded and displayed in gray.

Image Size of Easy Panorama

There are four different image sizes (in pixels), as described below.

When STD Normal is set

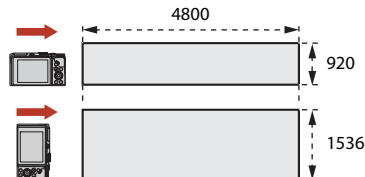

When WIDE Wide is set

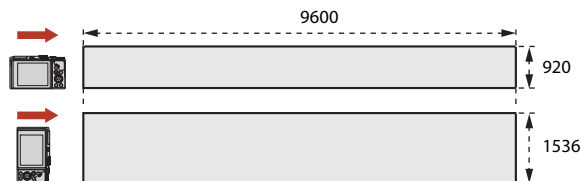

Playback with Easy Panorama

Switch to playback mode (📖20), display an image captured using easy panorama in full-frame playback mode, and then press the **OK** button to scroll the image in the direction that was used when shooting.

- Rotate the multi selector to fast-forward or rewind scroll playback.

Playback controls are displayed on the screen during playback.

Use the multi selector **◀▶** to select a control, and then press the **OK** button to perform the operations described below.



Function	Icon	Description
Rewind		Hold down the OK button to rewind scroll playback.*
Fast-forward		Hold down the OK button to fast-forward scroll playback.*
Pause		Pause playback. The operations listed below can be performed while paused.
		Hold down the OK button to rewind.*
		Hold down the OK button to scroll.*
		Resume automatic scrolling.
End		Return to full-frame playback mode.

* These operations can also be performed by rotating the multi selector.

Notes About Easy Panorama Images

- The images cannot be edited on this camera.
- This camera may not be able to scroll the playback of, or zoom in on, easy panorama images captured with another make or model of digital camera.

Notes About Printing Panorama Images

The entire image may not be able to be printed depending on the printer's settings. Additionally, printing may not be possible depending on the printer.













Shooting with Smart Portrait (Enhancing Human Faces When Shooting)

You can take a picture with the glamour retouch function to enhance human faces.

Rotate the mode dial to **SCENE** → **MENU** button →  Smart portrait → 
button → **MENU** button

1 Press the multi selector , apply an effect.

- Use   to select the desired effect.
- Use   to select the amount of effect.
- You can simultaneously apply multiple effects.
 **Skin softening**,  **Foundation makeup**,  **Soft**,  **Vividness**,  **Brightness (Exp. +/-)**
- Select  **Exit** to hide the slider.
- After configuring the desired effects, press the  button to apply them.

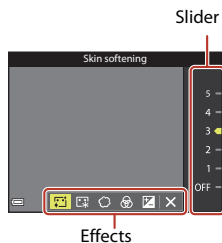





2 Frame the picture and press the shutter-release button.

Notes About Smart Portrait

The amount of effect may differ between the image on the shooting screen and the saved image.

Functions Available in Smart Portrait

- Self-Collage (47)
- Blink proof (48)
- Smile timer (49)
- Flash mode (57)
- Self-timer (60)



Using Self-Collage

The camera can capture a series of four or nine images at intervals and save them as a one-frame image (a collage image).



Rotate the mode dial to **SCENE** → **MENU** button → Smart portrait → button → Self-Collage → button

1 Select self-collage setting.

- **Number of shots:** Set the number of shots that the camera automatically captures (number of captured images for an aggregated image). **4** (default setting) or **9** can be selected.
- **Interval:** Set the interval time between each shot. **Short**, **Medium** (default setting), or **Long** can be selected.
- **Shutter sound:** Set whether to activate the shutter sound when shooting with the self-collage function.
Standard, **SLR**, **Magic** (default setting), or **Off** can be selected. If you set other than **Off**, countdown sound is produced.
The same setting that is specified for **Shutter sound** in **Sound settings** in the setup menu is not applied to this setting.
- After the settings are complete, press the **MENU** button or shutter-release button to exit the menu.

2 Press the multi selector to select **Self-Collage**, and press the button.

- A confirmation dialog is displayed.
- If you want to apply glamour retouch when shooting, set the effect before selecting self-collage (46).

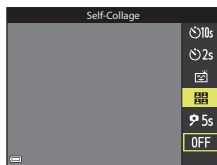

3 Take a picture.

- When you press the shutter-release button, a countdown starts (about five seconds) and the shutter is automatically released.
- The camera automatically releases the shutter for the remaining pictures. A countdown starts about three seconds before shooting.
- The number of shots is indicated by  in the monitor. It is displayed in green during shooting and it changes to white after shooting.

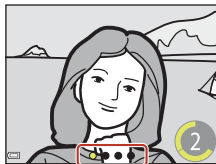

4 On the screen displayed when the camera finishes taking the specified number of shots, select **Yes** and press the button.

- The collage image is saved.
- Each captured image is saved as an individual image separate from the collage image. The images are grouped as a sequence, and a one-frame collage image is used as the key picture (79).
- When **No** is selected, the collage image is not saved.

Notes About Self-Collage

- If you press the shutter-release button before the camera takes the specified number of shots, shooting is canceled and the collage image is not saved. The pictures that were taken before shooting was canceled are saved as individual images.
- This function may not be available to use in combination with other functions (73).

Using Blink Proof

The camera automatically releases the shutter twice with every shot and saves one image in which the subject's eyes are open.

- If the camera saved an image in which the subject's eyes may have been closed, the dialog shown on the right is displayed for a few seconds.

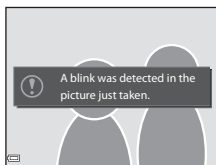

Rotate the mode dial to **SCENE** → **MENU** button →  Smart portrait → 
button → **Blink proof** → 

Select **On** or **Off** (default setting) in **Blink proof** and press the  button.

Notes About Blink Proof



This function may not be available to use in combination with other functions (73).



Using Smile Timer

The camera automatically releases the shutter whenever a smiling face is detected.



Rotate the mode dial to SCENE → MENU button →  Smart portrait →  button → MENU button

Press the multi selector  to select 
Smile timer and press the  button.

- Set the glamour retouch function before selecting smile timer (46).
- When you press the shutter-release button to take a picture, smile timer is terminated.



Notes About Smile Timer

- Under some shooting conditions, the camera may be unable to detect faces or smiles (68). The shutter-release button can also be used for shooting.
- This function may not be available to use in combination with other functions (73).

When the Self-timer Lamp Flashes

When using smile timer, the self-timer lamp flashes when the camera detects a face and flashes quickly immediately after the shutter is released.



Creative Mode (Applying Effects When Shooting)

The camera saves four images with effects and one image without effects simultaneously in one shot.

- The camera focuses in the center of the frame.

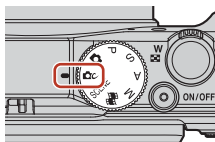

1 Press the **OK** button.

- The effect selection screen is displayed.

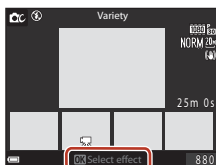

2 Use the multi selector **▲▼** to select the desired effect.

- You can select **Variety**, **Selective color (red)**, **Selective color (green)**, **Selective color (blue)**, **Light** (default setting), **Depth**, **Memory**, **Classic**, or **Noir**.
- The image without effects is displayed on the upper part of the screen. Four types of images with effects are displayed on the lower part of the screen.
- Only one type of effect can be applied to a movie. Press **◀▶** to select the desired effect.

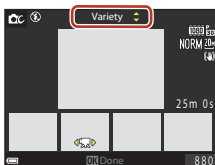





3 Press the shutter-release button or **●** (▶ movie-record) button to shoot.

- The five saved images are treated as a sequence. One image with an applied effect is used as the key picture (📖79).



Functions Available in Creative Mode

The functions below are available when you press the  button in step 2:

- Flash mode ( 57)
- Self-timer ( 60)
- Macro mode ( 61)
- Exposure compensation ( 64)



P, S, A, and M Modes (Setting the Exposure for Shooting)

In **P**, **S**, **A**, and **M** modes, you can set exposure (combination of shutter speed and f-number) according to the shooting conditions. Also, you can achieve greater control when shooting images by setting the shooting menu options (📖112).

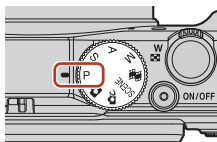

Shooting mode	Description
P Programmed auto	<p>You can let the camera adjust the shutter speed and f-number.</p> <ul style="list-style-type: none"> The combination of shutter speed and f-number can be changed by rotating the command dial or multi selector (flexible program). While the flexible program is in effect, the X (flexible program mark) is displayed on the upper left of the screen. To cancel the flexible program, rotate the command dial or multi selector in the opposite direction than when you set it until the X is no longer displayed, change the shooting mode, or turn off the camera.
S Shutter-priority auto	Rotate the command dial or multi selector to set the shutter speed. The camera automatically determines the f-number.
A Aperture-priority auto	Rotate the command dial or multi selector to set the f-number. The camera automatically determines the shutter speed.
M Manual	Set both the shutter speed and f-number. Rotate the command dial to set the shutter speed. Rotate the multi selector to set the f-number.

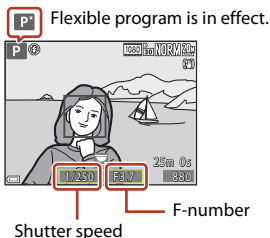
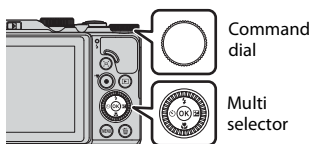

Tips for Setting Exposure

The sense of dynamism and amount of background defocus in subjects vary by changing the combinations of shutter speed and f-number even if the exposure is the same.

Effect of the Shutter Speed

The camera can make a fast-moving subject appear static at a fast shutter speed, or highlight the motion of a moving subject at a slow shutter speed.



Faster
1/1000 s



Slower
1/30 s

Effect of the F-number

The camera can bring the subject, foreground and background into focus, or blur the subject's background intentionally.



Small f-number
(larger aperture)
f/3.4



Large f-number
(smaller aperture)
f/8

Shutter Speed and F-number

- The control range of the shutter speed differs depending on the zoom position, f-number, or ISO sensitivity setting.
- The f-number of this camera also changes depending on the zoom position.
- When zooming is performed after the exposure is set, exposure combinations or the f-number may be changed.
- Large apertures (expressed by small f-numbers) let more light into the camera, and small apertures (large f-numbers) let less light. The smallest f-number represents the largest aperture, and the largest f-number represents the smallest aperture.



✓ Notes About Setting Exposure

When the subject is too dark or too bright, it may not be possible to obtain the appropriate exposure. In such cases, the shutter speed indicator or f-number indicator flashes (in **P**, **S**, and **A** modes), or the exposure indicator is displayed in red (in **M** mode) when the shutter-release button is pressed halfway. Change the shutter speed setting or f-number.

Exposure Indicator (When in **M** Mode)

The degree of deviation between the adjusted exposure value and the optimal exposure value measured by the camera is displayed in the exposure indicator on the screen. The degree of deviation in the exposure indicator is displayed in terms of EV (-2 to +2 EV in increments of 1/3 EV).

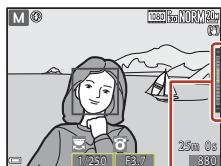

Exposure indicator

✓ Notes About ISO Sensitivity

When **ISO sensitivity** (📖115) is set to **Auto** (default setting) or **Fixed range auto**, the ISO sensitivity in **M** mode is fixed at ISO 80.

Functions Available in **P**, **S**, **A**, and **M** Modes

- Flash mode (📖56)
- Self-timer (📖56)
- Macro mode (📖56)
- Creative slider (📖56)
- Shooting menu (📖112)



📎 Focus Area

The focus area for autofocus varies depending on the setting of **AF area mode** (📖115) in the shooting menu. When set to **Target finding AF** (default setting), the camera detects the main subject and focuses on it (📖67). If a human face is detected, the camera automatically sets focus priority on it.



The Control Range of the Shutter Speed (P, S, A, and M Modes)

The control range of the shutter speed differs depending on the zoom position, f-number, or ISO sensitivity setting. Additionally, the control range changes in the following continuous shooting settings.

Setting		Control range (second)			
		P mode	S mode	A mode	M mode
ISO sensitivity ( 125) ¹	Auto ²	1/2000–1 s	1/2000–2 s		1/2000–8 s
	ISO 80–400 ² , ISO 80–800 ²		1/2000–4 s		
	ISO 80, 100, 200		1/2000–8 s		
	ISO 400, 800		1/2000–4 s		
	ISO 1600		1/2000–2 s		
	ISO 3200		1/2000–1 s		
Continuous ( 123)	Continuous H, Continuous L	1/2000–1 s			
	Pre-shooting cache	1/4000–1/120 s			
	Continuous H: 120 fps				
	Continuous H: 60 fps	1/4000–1/60 s			

¹ The ISO sensitivity setting is restricted depending on the continuous shooting setting ( 73).

² In **M** mode, the ISO sensitivity is fixed at ISO 80.



Setting Shooting Functions with the Multi Selector

When the shooting screen is displayed, you can press the multi selector ▲ (⚡) ◀ (⌚) ▼ (🌸) ▶ (📷) to set the functions described below.



- **⚡ Flash mode**
When the flash is raised, the flash mode can be set according to shooting conditions.
- **⌚ Self-timer/Self-portrait timer**
 - Self-timer: The shutter is automatically released in 10 or 2 seconds.
 - Self-portrait timer: The camera focuses in 5 seconds, and the shutter is automatically released.
- **🌸 Macro mode**
Use macro mode when you take close-up pictures.
- **📷 Creative slider (📷 brightness (exposure compensation), 🌈 vividness, 🎨 hue, and 🗨️ Active D-Lighting)**
You can adjust overall image brightness (exposure compensation).
In **Smart portrait** scene mode, you can apply glamour retouch to enhance human faces.
In **P**, **S**, **A**, and **M** mode, you can adjust overall image brightness, vividness, hue, and Active D-Lighting.

The functions that can be set vary depending on the shooting mode.



Flash Mode

When the flash is raised, the flash mode can be set according to shooting conditions.

1 Move the ⚡ (flash pop-up) control to raise the flash.

- When the flash is lowered, flash operation is disabled and Ⓜ is displayed.

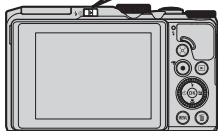
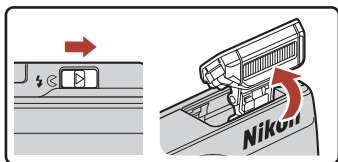

2 Press the multi selector ▲ (⚡).



3 Select the desired flash mode (📖58) and press the Ⓜ button.

- If the setting is not applied by pressing the Ⓜ button, the selection will be canceled.

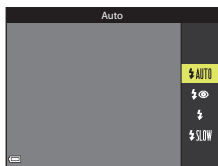

The Flash Lamp

- The status of the flash can be confirmed by pressing the shutter-release button halfway.
 - On: The flash fires when you press the shutter-release button all the way down.
 - Flashing: The flash is charging. The camera cannot shoot images.
 - Off: The flash does not fire when a picture is taken.
- If the battery level is low, the monitor turns off while the flash is charging.

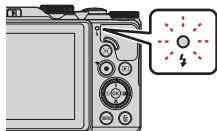

Available Flash Modes

AUTO Auto

The flash fires when necessary, such as in dim lighting.

- The flash mode indicator is only displayed immediately after setting on the shooting screen.

Auto with red-eye reduction/Red-eye reduction

Reduce red-eye in portraits caused by the flash ( 59).

- When **Red-eye reduction** is selected, the flash fires whenever a picture is taken.

Fill flash/Standard flash

The flash fires whenever a picture is taken.

SLOW Slow sync

Suited to evening and night portraits that include background scenery. The flash fires when necessary to illuminate the main subject; slow shutter speeds are used to capture background at night or under dim lighting.



















Notes About Using the Flash

When you use the flash at the wide-angle zoom position, the edge of the image may be dark depending on the shooting distance.

This may be improved by adjusting the zoom slightly to a telephoto position.

The Flash Mode Setting

The available flash modes differ depending on the shooting mode.

Flash mode	 	SCENE		P ¹	S ¹	A ¹	M ¹
 AUTO Auto		2	-	-	-	-	-
Auto with red-eye reduction			-	-	-	-	-
Red-eye reduction	-		-				
Fill flash			-	-	-	-	-
Standard flash	-		-				
 SLOW Slow sync			-		-		-

¹ For shooting modes **P**, **S**, **A** and **M**, the setting is saved in the camera's memory even after the camera is turned off.

² Availability depends on the setting. See "Default Settings (Flash, Self-timer, and Macro Mode)" ( 71) for more information.



Auto with Red-eye Reduction/Red-eye Reduction

Pre-flashes are fired repeatedly at low intensity before the main flash, reducing the red-eye effect. If the camera detects red-eye while saving an image, the affected area is processed to reduce red-eye before the image is saved.

Note the following when shooting:

- Because pre-flashes are fired, there is a slight lag between when the shutter-release button is pressed and when the image is shot.
- More time than usual is required to save images.
- Red-eye reduction may not produce the desired results in some situations.
- In rare cases, red-eye reduction may be applied to areas of an image unnecessarily. In these cases, select another flash mode and take the picture again.



Self-timer

The camera is equipped with a self-timer that releases the shutter few seconds after you press the shutter-release button. Set **Photo VR** (📖150) to **Off** in the setup menu when using a tripod to stabilize the camera during shooting.

1 Press the multi selector ◀ (👁).



2 Select the desired self-timer mode, and press the (OK) button.

- 👁10s (10 seconds): Use on important occasions, such as weddings.
- 👁2s (2 seconds): Use to prevent camera shake.
- 📷5s (5 seconds): Use to take self-portraits.
- If the setting is not applied by pressing the (OK) button, the selection will be canceled.
- When the shooting mode is **Pet portrait** scene mode, 🐾 (pet portrait auto release) (📖40) and 📷5s (self-portrait timer) are displayed.
- When the shooting mode is **Smart portrait** scene mode, 😊 (smile timer) or 📷 (self-collage) can also be selected (📖49, 47).

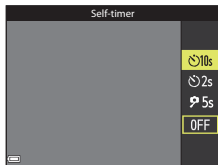

3 Frame the picture and press the shutter-release button halfway.

4 Press the shutter-release button all the way down.

- Countdown starts. The self-timer lamp flashes and then glows steadily about one second before the shutter is released.
- When the shutter is released, the self-timer is set to **OFF**.
- To stop the countdown, press the shutter-release button again.

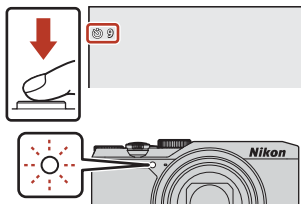

📌 Self-timer Focus and Exposure

Depending on the setting, timing to set focus and exposure is different.

- 👁10s / 👁2s: Focus and exposure are set when the button is pressed halfway in step 3.
- 📷5s: Focus and exposure are set just before the shutter is released.



Macro Mode (Taking Close-up Pictures)

Use macro mode when taking close-up pictures.

- 1 Press the multi selector ▼ (🌸).



- 2 Select **ON** and press the **OK** button.

- If the setting is not applied by pressing the **OK** button, the selection will be canceled.

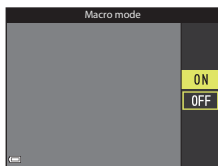

- 3 Move the zoom control to set the zoom ratio to a position where 🌸 and the zoom indicator are displayed in green.

- When the zoom ratio is set to a position where the zoom indicator is displayed in green, the camera can focus on subjects as close as approximately 10 cm (4 in.) from the lens.
When the zoom is at the position where 🌸 is displayed, the camera can focus on subjects as close as approximately 1 cm (0.4 in.) from the lens.



The Macro Mode Setting

- The setting may not be available with some shooting modes (📖71).
- If the setting is applied in **P**, **S**, **A**, or **M** mode or short movie show mode, it will remain saved in the camera's memory even after the camera is turned off.







Using the Creative Slider

When the shooting mode is set to **P**, **S**, **A**, or **M** mode, you can adjust the brightness (exposure compensation), vividness, hue, and Active D-Lighting when shooting.



- 1 Press the multi selector .



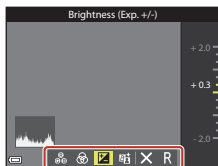

- 2 Use   to select an item.

-  **Hue**: Adjust the hue (reddish/bluish) of the entire image.
-  **Vividness**: Adjust the vividness of the entire image.
-  **Brightness (Exp. +/-)**: Adjust the brightness of the entire image.
-  **Active D-Lighting**: Reduce the loss of details in highlights and shadows. Select **暗H** (High), **暗N** (Normal), **暗L** (Low) for the amount of effect.



- 3 Use   to adjust the level.

- You can preview the results on the screen.
- To set another item, return to step 2.
- Select  **Exit** to hide the slider.
- To cancel all settings, select  **Reset** and press the  button. Return to step 2 and adjust the settings again.

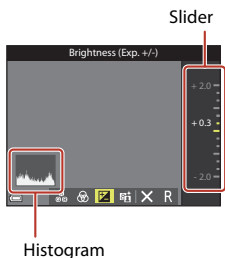

- 4 Press the  button when setting is complete.

- The settings are applied and the camera returns to the shooting screen.



Creative Slider Settings

- This function may not be available to use in combination with other functions (📖73).
- The settings for brightness (exposure compensation), vividness, hue, and Active D-Lighting are saved in the camera's memory even after the camera is turned off.
- When the shooting mode is set to **M** mode, **Active D-Lighting** cannot be used.
- See "Using the Histogram" (📖64) for more information.

Active D-Lighting Versus D-Lighting

- The **Active D-Lighting** option in the shooting menu captures images while reducing loss of details in highlights, and adjusts the tone when saving images.
- The **D-Lighting** (📖82) option in the playback menu adjusts the tone of saved images.





Exposure Compensation (Adjusting Brightness)

When the shooting mode is set to  (auto) mode, scene mode, creative mode, or short movie show mode, you can adjust the brightness (exposure compensation).

- 1 Press the multi selector .



- 2 Select a compensation value and press the  button.

- To brighten the image, set a positive (+) value.
- To darken the image, set a negative (-) value.
- The compensation value is applied, even without pressing the  button.

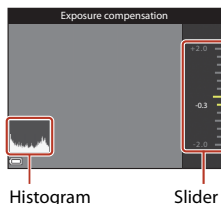

Exposure Compensation Value

- When the shooting mode is **Fireworks show**, Night sky and Star trails in **Time-lapse movie**, or **Multiple exp. Lighten** in scene mode, exposure compensation cannot be used.
- When the shooting mode is short movie show mode, the setting applied will remain saved in the camera's memory even after the camera is turned off.
- When the exposure compensation is set while using a flash, the compensation is applied to both the background exposure and the flash output.

Using the Histogram

A histogram is a graph showing the distribution of tones in the image. Use as a guide when using exposure compensation and shooting without the flash.

- The horizontal axis corresponds to pixel brightness, with dark tones to the left and bright tones to the right. The vertical axis shows the number of pixels.
- Increasing exposure compensation value shifts tone distribution to the right, and decreasing it shifts tone distribution to the left.



Using the Zoom

When you move the zoom control, the zoom lens position changes.

- To zoom in: Move toward **T**
- To zoom out: Move toward **W**

When you turn the camera on, the zoom moves to the maximum wide-angle position.

- Rotating the zoom control all the way in either direction adjusts the zoom quickly.
- A zoom indicator is displayed on the shooting screen when the zoom control is moved.
- Digital zoom, which allows you to further magnify the subject up to approximately 4x the maximum optical zoom ratio, can be activated by moving and holding the zoom control toward **T** when the camera is zoomed in to the maximum optical zoom position.

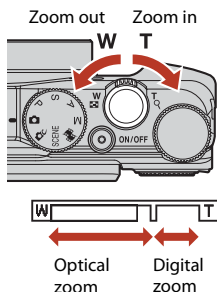

✓ Notes About Digital Zoom Magnification

When **Movie options** (📖 130) is set to **2160 P 2160/30p** (4K UHD) or **2160 P 2160/25p** (4K UHD), the digital zoom magnification is restricted up to approximately 2x.

📎 Digital Zoom



The zoom indicator changes to blue when the digital zoom is activated, and it changes to yellow when the zoom magnification is increased further.

- Zoom indicator is blue: Image quality is not noticeably reduced by using the Dynamic Fine Zoom.
- Zoom indicator is yellow: There may be cases in which image quality is noticeably reduced.
- The indicator remains blue across a wider area when the image size is smaller.
- The zoom indicator may not change to blue when using certain continuous shooting settings or other settings.



Using the Snap-back Zoom

If you lose sight of the subject while shooting with the lens in telephoto position, press the  (snap-back zoom) button to temporarily widen the visible area (angle of view) so that you can frame the subject more easily.

- While pressing the  button, frame the subject inside the framing border of the shooting screen. To change the visible area, move the zoom control while pressing the  button.
- Release the  button to return to the original zoom position.
- Snap-back zoom is not available during movie recording.

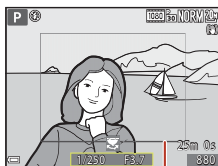
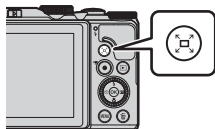

Framing border



Focusing

The Shutter-release Button

Press halfway



To press the shutter-release button “halfway” means to press and hold the button at the point where you feel a slight resistance.

- Focus and exposure (shutter speed and f-number) are set when you press the shutter-release button halfway. Focus and exposure remain locked while the button is pressed halfway.
- The focus area varies depending on the shooting mode.

Press all the way



To press the shutter-release button “all the way” means to press the button down completely.

- The shutter is released when the shutter-release button is pressed all the way.
- Do not use force when pressing the shutter-release button, as this may result in camera shake and blurred images. Press the button gently.

Using Target Finding AF

In  (auto) mode or when **AF area mode** (📖126) in **P**, **S**, **A**, or **M** mode is set to **Target finding AF**, the camera focuses in the manner described below when you press the shutter-release button halfway.

- The camera detects the main subject and focuses on it. When the subject is in focus, the focus area is displayed in green. If a human face is detected, the camera automatically sets focus priority on it.

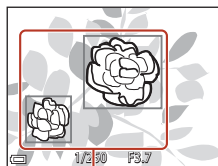

Focus areas

- If no main subject is detected, the camera automatically selects one or more of the nine focus areas containing the subject closest to the camera. When the subject is in focus, the focus areas that are in focus are displayed in green.

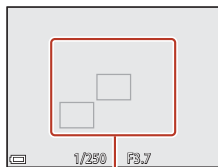

Focus areas



✓ Notes About Target Finding AF

- Depending on shooting conditions, the subject that the camera determines to be the main subject may vary.
- The main subject may not be detected when using certain **White balance** settings.
- The camera may not detect the main subject appropriately in the following situations:
 - When the subject is very dark or bright
 - When the main subject lacks clearly defined colors
 - When the shot is framed so that the main subject is on the edge of the screen
 - When the main subject is composed of a repeating pattern

Using Face Detection

In the following settings, the camera uses face detection to automatically focus on human faces.

- **Scene auto selector**, **Portrait**, **Night portrait**, or **Smart portrait** scene mode (📖35)
- When **AF area mode** (📖126) is set to **Face priority**

If the camera detects more than one face, a double border is displayed around the face that the camera focuses on, and single borders are displayed around the other faces.

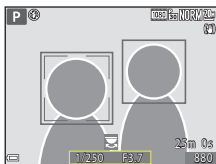

If the shutter-release button is pressed halfway when no faces are detected:

- When **Scene auto selector** is selected, the focus area changes depending on the shooting conditions that the camera recognizes.
- In **Portrait**, **Night portrait**, or **Smart portrait**, the camera focuses on the area in the center of the frame.
- When **AF area mode** is set to **Face priority**, the camera selects the focus area containing the subject closest to the camera.

✓ Notes About Face Detection

- The camera's ability to detect faces depends on a variety of factors, including the direction in which the faces are looking.
- The camera cannot detect faces in the following situations:
 - When faces are partially hidden by sunglasses or otherwise obstructed
 - When faces take up too much or too little of the frame

📎 Face Detection During Movie Recording

When **AF area mode** (📖134) in the movie menu is set to **Face priority**, the camera focuses on human faces during movie recording.

If the **AF-ON** button is pressed when no faces are detected, the camera focuses on the area in the center of the frame.



Subjects Not Suitable for Autofocus

The camera may not focus as expected in the following situations. In rare cases, the subject may not be in focus despite the fact that the focus area or the focus indicator is displayed in green:

- Subject is very dark
- Objects of sharply differing brightness are included in the shooting conditions (e.g. the sun behind the subject makes that subject appear very dark)
- No contrast between the subject and surroundings (e.g. a portrait subject wearing a white shirt is standing in front of a white wall)
- Several objects are at different distances from the camera (e.g. the subject is inside a cage)
- Subjects with repeating patterns (window blinds, buildings with multiple rows of similarly shaped windows, etc.)
- Subject is moving rapidly

In the situations noted above, try pressing the shutter-release button halfway to refocus several times, or focus on another subject positioned at the same distance from the camera as the actual desired subject, and use focus lock (📖70).



Focus Lock

Focus lock shooting is recommended when the camera does not activate the focus area that contains the desired subject.

1 In **P**, **S**, **A**, or **M** mode, set **AF area mode** to **Center** (📖126).

2 Position the subject in the center of the frame and press the shutter-release button halfway.

- The camera focuses on the subject and the focus area is displayed in green.
- Exposure is also locked.

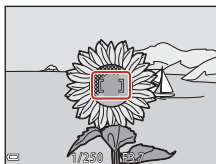

3 Without lifting your finger, recompose the picture.

- Make sure to maintain the same distance between the camera and the subject.



4 Press the shutter-release button all the way down to take the picture.























































Moving the Focus Area to the Desired Position

In **P**, **S**, **A**, or **M** shooting mode, the focus area can be moved using the multi selector by setting **AF area mode** (📖126) in the shooting menu to one of the manual options.











Default Settings (Flash, Self-timer, and Macro Mode)

The default settings for each shooting mode are listed below.

	Flash ( 56)	Self-timer ( 56)	Macro mode ( 61)
 (auto)	 AUTO	OFF	OFF
 (creative mode)	 AUTO	OFF	OFF
SCENE			
 (scene auto selector)	 AUTO ¹	OFF	OFF ²
 (portrait)	 	OFF	OFF ³
 (landscape)	 ³	OFF	OFF ³
 (time-lapse movie)	 ³	OFF	OFF ³
 (sports)	 ³	OFF ³	OFF ³
 (night portrait)	  ³	OFF	OFF ³
 (party/indoor)	  ⁴	OFF	OFF ³
 (beach)	 AUTO	OFF	OFF ³
 (snow)	 AUTO	OFF	OFF ³
 (sunset)	 ³	OFF	OFF ³
 (dusk/dawn)	 ³	OFF	OFF ³
 (night landscape)	 ³	OFF	OFF ³
 (close-up)	 AUTO	OFF	ON ³
 (food)	 ³	OFF	ON ³
 (fireworks show)	 ³	OFF ³	OFF ³
 (backlighting)	  ⁵	OFF	OFF ³
 (easy panorama)	 ³	OFF ³	OFF ³
 (pet portrait)	 ³	 ⁶	OFF
 (multiple exp. lighten)	 ³	 2s	OFF ³
 (superlapse movies)	 ³	OFF	OFF
 (smart portrait)	 AUTO ⁷	OFF ⁸	OFF ³
 (short movie show)	 ³	OFF	OFF
P, S, A, and M		OFF	OFF





- 1 Cannot be changed. The camera automatically selects the flash mode appropriate for the scene it has selected.
- 2 Cannot be changed. The camera enters macro mode when  is selected.
- 3 Cannot be changed.
- 4 May switch to slow sync with red-eye reduction flash mode.
- 5 Flash is fixed at  (fill flash) when **HDR** is set to **Off**, and is fixed at  (off) when **HDR** is set to **On**.
- 6 Pet portrait auto release ()40), self-portrait timer, and **OFF** can be set.
- 7 Cannot be used when **Blink proof** is set to **On**.
- 8 Other than self-timer,  (smile timer) ()49) and  (self-collage) ()47) can be also used.



Functions That Cannot Be Used Simultaneously When Shooting

Some functions cannot be used with other menu settings.

Restricted function	Option	Description
Flash mode	Continuous (📖123)	When a setting other than Single is selected, the flash cannot be used.
	Blink proof (📖48)	When Blink proof is set to On , the flash cannot be used.
Self-timer	AF area mode (📖126)	When Subject tracking is selected, the self-timer cannot be used.
Macro mode	AF area mode (📖126)	When Subject tracking is selected, macro mode cannot be used.
Image quality	Continuous (📖123)	When Pre-shooting cache , Continuous H: 120 fps , or Continuous H: 60 fps is selected, the setting is fixed at Normal .
Image size	Continuous (📖123)	Image size is set as follows depending on the continuous shooting setting: <ul style="list-style-type: none"> • Pre-shooting cache:  (image size: 1280 × 960 pixels) • Continuous H: 120 fps:  640×480 • Continuous H: 60 fps:  (image size: 1280 × 960 pixels)
White balance	Hue (using the creative slider) (📖62)	When hue is adjusted using the creative slider, White balance in the shooting menu cannot be set. To set White balance , select  in the creative slider setting screen to reset the brightness, vividness, hue, and Active D-Lighting.
Continuous	Self-timer (📖60)	If the self-timer is used when Pre-shooting cache is selected, the setting is fixed at Single .
ISO sensitivity	Continuous (📖123)	When Pre-shooting cache , Continuous H: 120 fps , or Continuous H: 60 fps is selected, the ISO sensitivity setting is automatically specified according to the brightness.
AF area mode	White balance (📖120)	When a setting other than Auto is selected for White balance in Target finding AF mode, the camera does not detect the main subject.



Restricted function	Option	Description
Blink proof	Smile timer (📖49)	When Smile timer is set, Blink proof cannot be used.
	Self-Collage (📖47)	When Self-Collage is set, Blink proof cannot be used.
Date stamp	Continuous (📖123)	When Continuous H , Continuous L , Pre-shooting cache , Continuous H: 120 fps , or Continuous H: 60 fps is selected, date and time cannot be stamped on images.
Photo VR	Flash mode (📖57)	If the flash fires when On (hybrid) is selected, the setting is fixed at On .
	Self-timer (📖60)	If the self-timer is used when On (hybrid) is selected, the setting is fixed at On .
	Continuous (📖123)	If Continuous is set to any setting other than Single when On (hybrid) is selected, the setting is fixed at On .
	ISO sensitivity (📖125)	If ISO sensitivity is set to Fixed range auto or ISO 400 or higher when On (hybrid) is selected, the setting is fixed at On .
Digital zoom	AF area mode (📖126)	When Subject tracking is selected, digital zoom cannot be used.

✓ Notes About Digital Zoom

- Depending on the shooting mode or the current settings, digital zoom may not be available (📖151).
- When digital zoom is in effect, the camera focuses in the center of the frame.



Playback Features

Playback Zoom.....	76
Thumbnail Playback/Calendar Display.....	77
List by Date Mode	78
Viewing and Deleting Images in a Sequence.....	79
Editing Images (Still Images).....	81



Playback Zoom

Moving the zoom control toward **T** (Q playback zoom) in full-frame playback mode (📖20) zooms in on the image.

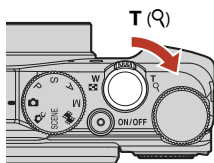

Full-frame Playback



Image is zoomed in.

Displayed area guide

- You can change the magnification rate by moving the zoom control toward **W** (📐) or **T** (Q). The zoom can also be adjusted by rotating the command dial.
- To view a different area of the image, press the multi selector ▲▼◀▶.
- When a zoomed image is displayed, press the **OK** button to return to full-frame playback mode.

Cropping Images

When a zoomed image is displayed, you can press the **MENU** button to crop the image to include only the visible portion and save it as a separate file (📖86).



Thumbnail Playback/Calendar Display

Moving the zoom control toward **W** (📷) thumbnail playback) in full-frame playback mode (📖20) displays images as thumbnails.

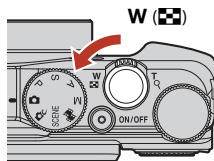



- You can change the number of thumbnails displayed by moving the zoom control toward **W** (📷) or **T** (📷).
- While using thumbnail playback mode, use the multi selector **▲▼◀▶** or rotate it to select an image, and then press the **OK** button to display that image in full-frame playback mode.
- While using calendar display mode, use **▲▼◀▶** or rotate it to select a date, and then press the **OK** button to display the images captured on that day.

✓ Notes About Calendar Display

Images captured when the camera's date is not set are treated as images captured on January 1, 2016.



List by Date Mode

Press the  button (playback mode) → MENU button → MODE menu icon →  List by date →  button

Use the multi selector ▲▼ to select a date and then press the  button to play back the images captured on the selected date.





- Functions in the playback menu ( 112) can be used for the images in the selected shooting date (except **Copy**).
- The following operations are available while the shooting date selection screen is displayed.
 - MENU button: The functions listed below are available.

- **Slide show**

- **Protect***

* The same setting can be applied to all images captured on the selected date.

-  button: Deletes all images captured on the selected date.

List by date		
	30/11/2016	[3]
	25/11/2016	[2]
	20/11/2016	[11]
	15/11/2016	[4]

Notes About List by Date Mode

- Up to the most recent 29 dates can be selected. If images exist for more than 29 dates, all images saved earlier than the most recent 29 dates will be combined under **Others**.
- The 9,000 most recent images can be displayed.
- Images captured when the camera's date is not set are treated as images captured on January 1, 2016.



Viewing and Deleting Images in a Sequence

Viewing Images in a Sequence

Images captured continuously, or with the multiple exp. lighten, self-collage, or creative mode function, are saved as a sequence.

One image in a sequence is used as the key picture to represent the sequence when displayed in full-frame playback mode or thumbnail playback mode.

To display each image in the sequence individually, press the **OK** button.

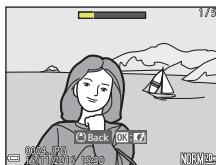

After pressing the **OK** button, the operations listed below are available.

- To display the previous or next image, rotate the multi selector or press **◀▶**.
- To display images that are not included in the sequence, press **▲** to return to the key picture display.
- To display images in a sequence as thumbnails, or to play them back in a slide show, set **Sequence display options** to **Individual pictures** in the playback menu (📖142).

✔ **Sequence Display Options**

Images captured with cameras other than this camera cannot be displayed as a sequence.

📎 **Playback Menu Options Available When Using Sequence**

- When images in a sequence are displayed in full-frame playback mode, press the **MENU** button to select functions in playback menu (📖112).
- If you press the **MENU** button when a key picture is displayed, the following settings can be applied to all images in the sequence:
 - Mark for upload, Protect, Copy



Deleting Images in a Sequence

When the  (delete) button is pressed for images in a sequence, the images that are deleted vary depending on how the sequences are displayed.

- When the key picture is displayed:
 - **Current image:** All images in the displayed sequence are deleted.
 - **Erase selected images:** When a key picture is selected on the erase selected images screen (22), all images in that sequence are deleted.
 - **All images:** All images on the memory card or in the internal memory are deleted.
- When images in a sequence are displayed in full-frame playback mode:
 - **Current image:** The image currently displayed is deleted.
 - **Erase selected images:** Images that are selected in the sequence are deleted.
 - **Entire sequence:** All images in the displayed sequence are deleted.



Editing Images (Still Images)

Before Editing Images

You can easily edit images on this camera. Edited copies are saved as separate files. Edited copies are saved with the same shooting date and time as the original.

Restrictions on Image Editing

- An image can be edited up to 10 times. A still image created by editing a movie can be edited up to nine times.
- You may not be able to edit images of a certain size or with certain editing functions.

Quick Effects: Changing Hue or Mood

Images can be processed with a variety of effects.

Select **Painting**, **Photo illustration**, **Soft portrait**, **Portrait (color + B&W)**, **Fisheye**, **Cross screen** or **Miniature effect**.

- 1 Display the image to which you want to apply an effect in fullframe playback mode and press the **OK** button.



- 2 Use the multi selector **▲▼◀▶** or rotate it to select the desired effect and press the **OK** button.

- Move the zoom control (**Ⓛ2**) toward **T** (**📷**) to switch to full-frame playback or **W** (**📄**) to switch to thumbnail playback.
- To exit without saving the edited image, press the **MENU** button.

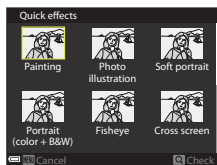



- 3 Select **Yes** and press the **OK** button.

- An edited copy is created.



Quick Retouch: Enhancing Contrast and Saturation



Press the  button (playback mode) → Select an image → MENU button → Quick retouch →  button

Use the multi selector ▲▼ to select the desired effect level and press the  button.

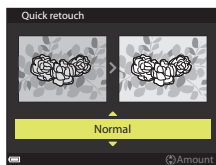
- The edited version is displayed on the right.
- To exit without saving the copy, press .



D-Lighting: Enhancing Brightness and Contrast



Press the  button (playback mode) → Select an image → MENU button → D-Lighting →  button

Use the multi selector ▲▼ to select **OK** and press the  button.

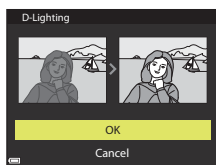
- The edited version is displayed on the right.
- To exit without saving the copy, select **Cancel** and press the  button.



Red-eye Correction: Correcting Red-eye When Shooting with the Flash

Press the  button (playback mode) → Select an image → MENU button → Red-eye correction →  button

Preview the result and press the  button.

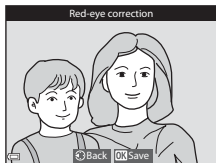

- To exit without saving the copy, press the multi selector .





Notes About Red-eye Correction

- Red-eye correction can only be applied to images when red-eye is detected.
- Red-eye correction can be applied to pets (dogs or cats) even if their eyes are not red.
- Red-eye correction may not produce the desired results in some images.
- In rare cases, red-eye correction may be applied unnecessarily to other areas of the image.

Glamour Retouch: Enhancing Human Faces

Press the  button (playback mode) → Select an image → MENU button → Glamour retouch →  button

1 Use the multi selector  to select the face that you want to retouch and press the  button.

- When only one face is detected, proceed to step 2.

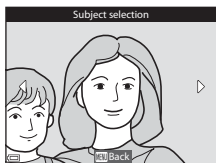

2 Use ◀▶ to select the effect, use ▲▼ to select the effect level, and press the OK button.

- You can simultaneously apply multiple effects. Adjust or check the settings for all effects before pressing the OK button.
😊 (small face), 🌫️ (skin softening), 🏠 (foundation makeup), 🌫️ (glare reduction), 😊 (hide eye bags), 😊 (big eyes), 😊 (whiten eyes), 😊 (eye shadow), 🖐️ (mascara), 😊 (whiten teeth), 😊 (lipstick), 😊 (redden cheeks)
- Press the MENU button to return to the screen for selecting a face.

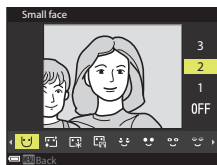

3 Preview the result and press the OK button.

- To change the settings, press ◀ to return to step 2.
- To exit without saving the edited image, press the MENU button.

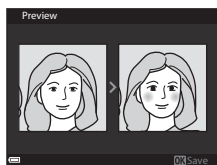

4 Select Yes and press the OK button.

- An edited copy is created.

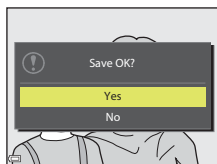



✓ Notes About Glamour Retouch

- One face at a time can be edited. To use the glamour retouch function for another face, edit the edited image again.
- Depending on the direction in which faces are looking, or the brightness of faces, the camera cannot accurately detect faces, or the glamour retouch function may not perform as expected.
- If no faces are detected, a warning is displayed and the screen returns to the playback menu.
- The glamour retouch function is available only for images captured at an ISO sensitivity of 1600 or lower, and the image size of 640 × 480 or larger.



Small Picture: Reducing the Size of an Image

Press the  button (playback mode) → Select an image → MENU button → Small picture →  button

1 Use the multi selector to select the desired copy size and press the button.

- When the aspect ratio of the image is 16:9, the image size is fixed at 640 × 360. When the aspect ratio of the image is 1:1, the image size is fixed at 480 × 480. Press the  button to proceed to step 2.

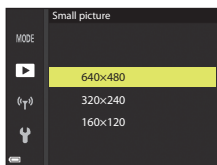

2 Select **Yes** and press the button.

- An edited copy is created (compression ratio of approximately 1:8).

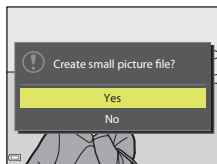

Crop: Creating a Cropped Copy

1 Move the zoom control to enlarge the image (📖76).

2 Adjust the image so that only the portion that you want to keep is displayed, and then press the **MENU** (menu) button.

- Move the zoom control toward **T** (🔍) or **W** (📐) to adjust the magnification rate. Set a magnification rate at which 📐:🔍 is displayed.
- Use the multi selector ▲▼◀▶ to scroll to the portion of the image that you want to display.



3 Check the image and press the **OK** button.

- To change the portion you want to keep, return to step 2 by pressing ◀.
- To exit without saving the cropped image, press the **MENU** button.

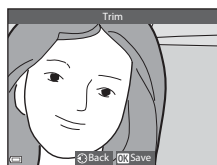

4 Select **Yes** and press the **OK** button.

- An edited copy is created.



Image Size

- The aspect ratio (horizontal to vertical) of the cropped copy is the same as the original.
- When the image size of the cropped copy is 320 × 240 or smaller, the image is displayed at a smaller size during playback.



Movies

Basic Operations of Movie Recording and Movie Playback.....	88
Capturing Still Images While Recording Movies.....	91
Shooting Time-lapse Movies.....	92
Recording Superlapse Movies.....	94
Short Movie Show Mode (Combining Movie Clips to Create Short Movies).....	95
Operations During Movie Playback.....	98
Editing Movies.....	99



Basic Operations of Movie Recording and Movie Playback

1 Display the shooting screen.

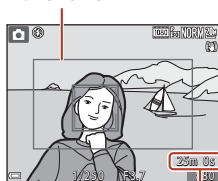

- Check the remaining amount of movie recording time.
- It is recommended that you display the movie frame that indicates the area that will be recorded in a movie (📖89).

Movie frame



Remaining movie recording time

2 Press the movie-record button to start movie recording.

- The focus area for autofocus differs depending on the setting of **AF area mode** (📖134). The default setting is **Face priority**.
- Press the multi selector  to pause recording, and press  again to resume recording (except when an HS movie option is selected in **Movie options**). Recording automatically ends if it remains paused for about five minutes.
- You can capture a still image by pressing the shutter-release button while recording a movie (📖91).

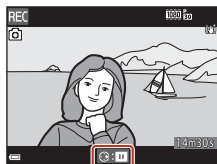
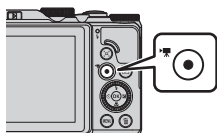

3 Press the button again to end recording.

4 Select a movie in full-frame playback mode and press the button to play it back.

- An image with a movie options icon is a movie.

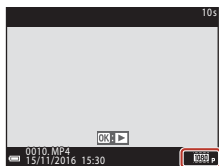

Movie options



Movie Frame

- Set **Photo info** in **Monitor settings** in the setup menu to **Movie frame+auto info** (📖147) to display the movie frame. Check the range of a movie in a frame before recording.
- The area that is recorded in a movie varies depending on the **Movie options** or **Movie VR** settings in the movie menu.

Maximum Movie Recording Time

Individual movie files cannot exceed 4 GB in size or 29 minutes in length, even when there is sufficient free space on the memory card for longer recording.

- The remaining recording time for a single movie is displayed on the shooting screen.
- Recording may end before either limit is reached if camera temperature becomes elevated.
- The actual remaining recording time may vary depending on the movie content, subject movement, or type of memory card.
- Cards rated Speed Class 6 or better are recommended for movie recording (when **Movie options** is set to $\frac{2160}{60}$ **2160/30p** (4K UHD) or $\frac{2160}{25}$ **2160/25p** (4K UHD), cards rated UHS Speed Class 3 or better are recommended); using slower cards may result in recording being interrupted.
- When using the camera's internal memory, saving movies may take some time.
- When using certain **Movie options** settings, it may not be possible to save the movie in the internal memory or copy it from a memory card to the internal memory.

✔ Camera Temperature

- The camera may become hot when recording movies for an extended period of time or when the camera is used in a hot area.
- If the inside of the camera becomes extremely hot when recording movies, the camera will automatically stop recording. The amount of time remaining until the camera stops recording (🕒10s) is displayed.
After the camera stops recording, it turns itself off.
Leave the camera off until the inside of the camera has cooled.



Notes About Movie Recording

✓ Notes About Saving Images or Movies

The indicator showing the number of exposures remaining or the indicator showing the remaining recording time flashes while images or movies are being saved. **Do not open the battery-chamber/memory card slot cover or remove the battery or memory card** while an indicator is flashing. Doing this could result in loss of data, or in damage to the camera or the memory card.

✓ Notes About Recorded Movies

- The zoom indicator is not displayed during movie recording.
- There may be some degradation in image quality when digital zoom is used.
- The sounds of zoom control operation, zoom, autofocus lens drive movement, vibration reduction, and aperture operation when brightness changes may be recorded.
- The following phenomena may be seen on the screen while recording movies. These phenomena are saved in the recorded movies.
 - Banding may occur in images under fluorescent, mercury-vapor, or sodium-vapor lighting.
 - Subjects that move quickly from one side of the frame to the other, such as a moving train or car, may appear skewed.
 - The entire movie image may be skewed when the camera is panned.
 - Lighting or other bright areas may leave residual images when the camera is moved.
- Depending on the distance to the subject or the amount of zoom applied, colored stripes may appear on subjects with repeating patterns (fabrics, lattice windows, etc.) during movie recording and playback. This occurs when the pattern in the subject and the layout of the image sensor interfere with each other; it is not a malfunction.

✓ Notes About Vibration Reduction During Movie Recording

- When **Movie VR** (📖136) in the movie menu is set to **On (hybrid)**, the angle of view (i.e., the area visible in the frame) becomes narrower during movie recording.
- When using a tripod to stabilize the camera during recording, set **Movie VR** to **Off** to prevent potential errors caused by this function.

✓ Notes About Autofocus for Movie Recording



Autofocus may not perform as expected (📖69). Should this occur, try the following:

1. Set **AF area mode** to **Center** and **Autofocus mode** to **Single AF** (default setting) in the movie menu before starting movie recording.
2. Frame another subject (positioned at the same distance from the camera as the intended subject) in the center of the frame, press the **● (📷)** button to start recording, and modify the composition.



Capturing Still Images While Recording Movies

If the shutter-release button is pressed all the way while recording a movie, one frame is saved as a still image. Movie recording continues while the still image is being saved.

- A still image can be captured when  is displayed on the screen. When  is displayed, a still image cannot be captured.
- The size of the captured still image is determined by the movie image size (130).



Notes About Capturing Still Images During Movie Recording

- Still images cannot be saved during movie recording in the following situations:
 - When movie recording is paused
 - When the remaining movie recording time is less than five seconds
 - When **Movie options** (130) is set to **2160p 2160/30p** (4K UHD) or **2160p 2160/25p** (4K UHD), **480p 480/30p** or **480p 480/25p**, or HS movie
- The frames of a movie that were recorded when a still image was being captured may not play back smoothly.
- The sounds of operating the shutter-release button when saving a still image may be heard in the recorded movie.
- If the camera moves when the shutter-release button is pressed, the image may be blurred.







Shooting Time-lapse Movies

The camera can automatically capture still images at a specified interval to create time-lapse movies that are approximately 10 seconds long.

- When the **Frame rate** setting of the movie menu is set to **30 fps (30p/60p)**, 300 images are captured and saved with **1080 P60 1080/30p**. When set to **25 fps (25p/50p)**, 250 images are captured and saved with **1080 P30 1080/25p**.

Rotate the mode dial to **SCENE** → **MENU** button →  Time-lapse movie → **OK** button

Type (required shooting time)	Interval time	
	30 fps (30p/60p)	25 fps (25p/50p)
 Cityscape (10 minutes) ¹ (default setting)	2 s	2.4 s
 Landscape (25 minutes) ¹	5 s	6 s
 Sunset (50 minutes) ¹	10 s	12 s
 Night sky (150 minutes) ^{2,3}	30 s	36 s
 Star trails (150 minutes) ^{3,4}	30 s	36 s

¹ The camera focuses on the area in the center of the frame.

² Suited for recording the movement of stars. The focus is fixed at infinity.

³ The telephoto zoom position is restricted to the angle of view equivalent to that of approx. 300 mm lens (in 35mm [135] format).

⁴ Star movement appears as lines of light due to image processing. The focus is fixed at infinity.

- Use the multi selector  to select a type, and press the **OK** button.

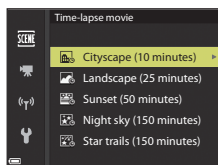

2 Select whether or not to fix exposure (brightness), and press the **OK** button. (except Night sky and Star trails)

- When **AE-L on** is selected, the exposure used for the first image is used for all images. When the brightness changes drastically like at dusk, **AE-L off** is recommended.

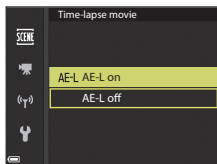

3 Stabilize the camera by using a tool such as a tripod.

4 Press the shutter-release button to capture the first image.

- Set exposure compensation (📖64) before releasing the shutter for the first image. Exposure compensation cannot be changed after the first image is captured. Focus and hue are fixed when the first image is captured.
- The shutter is automatically released for the second and subsequent images.
- The screen may turn off while the camera is not capturing images.
- Shooting ends automatically when 300 or 250 images are captured.
- Press the **OK** button to end shooting before the required shooting time elapses and create a time-lapse movie.
- Sound and still images cannot be saved.

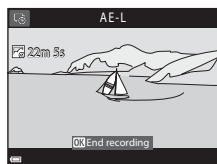

✓ **Notes About Time-lapse Movie**

- The camera cannot capture images if a memory card is not inserted. Do not exchange the memory card until shooting is complete.
- Use a sufficiently charged battery to prevent the camera from turning off unexpectedly.
- Time-lapse movies cannot be recorded by pressing the **●** (📷) button.
- Do not rotate the mode dial to a different setting until shooting is complete.
- Vibration reduction is disabled regardless of the **Photo VR** setting (📖150) in the setup menu.



Recording Superlapse Movies

The camera records movies and saves them in fast motion ($\frac{1080}{15}$ P 30 **1080/30p** or $\frac{1080}{25}$ P 25 **1080/25p**). Use to record a movie while moving the camera. The camera compresses the time of changes in the subject and saves the movie.



Rotate the mode dial to **SCENE** → **MENU** button →  Superlapse movie →  button

1 Select the playback speed from **Playback speed**, and press the button.

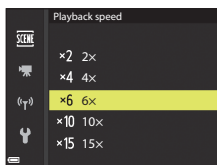
- At the default setting of **6x**, a movie recorded for six minutes is played back as a one-minute movie.
- Movies cannot exceed a recording time of 29 minutes.



2 Press the (movie-record) button to start recording.

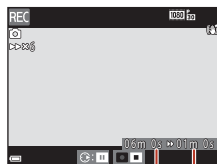

- The focus area for autofocus differs depending on the setting of **AF area mode** ( 126). The default setting is **Face priority**.
- You can check the recording time and playback time on the screen.
- It is recommended that you display the movie frame that indicates the area that will be recorded in a movie ( 147).
- Sound is not recorded.



Recording time

Playback time

Shooting Still Images

- A still image (**Normal** in image quality and $\frac{16:9}{15}$ H **5184x2920** in image size) can be captured if you press the shutter-release button before pressing the  (movie-record) button.
- You can shoot still images while recording movies ( 91).



Short Movie Show Mode (Combining Movie Clips to Create Short Movies)

You can create a short movie (**1080p 30** **1080/30p** or **1080p 25** **1080/25p**) that is up to 30 seconds long by recording and automatically combining multiple movie clips that are several seconds long.

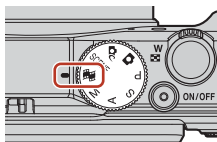

1 Press the **MENU** (menu) button and configure the settings for recording movies.

- **Number of shots:** Set the number of movie clips that the camera records and the recording time for each movie clip. By default, the camera records 15 movie clips that are 2 seconds each to create a 30-second short movie.
- **Special effects:** Apply various effects to movies when shooting (📖96). Effects can be changed for each movie clip.
- **Background music:** Select the background music. Move the zoom control (📖2) toward **T** (📖) to preview it.
- After the settings are complete, press the **MENU** button or shutter-release button to exit the menu.

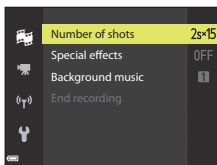

2 Press the **●** (📽 movie-record) button to record a movie clip.

- The camera stops recording the movie clip when the time specified in step 1 elapses.
- Movie clip recording can be paused temporarily. See "Pausing Movie Recording" (📖97).



3 Check the recorded movie clip, or delete it.

- To check it, press the **OK** button.
- To delete it, press the **🗑** button. The last recorded movie clip or all movie clips can be deleted.
- To continue recording movie clips, repeat the operation in step 2.
- To change the effects, return to step 1.

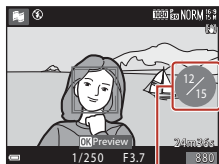





Number of movie clips recorded





4 Save the short movie show.

- The short movie show is saved when the camera finishes recording the specified number of movie clips.
- To save a short movie show before the camera finishes recording the specified number of movie clips, press the **MENU** button with the shooting screen displayed while a movie clip is not being recorded, and then select **End recording**.
- Movie clips are deleted when a short movie show is saved.

Special Effects

Function	Description
SOFT Soft	Softens the image by adding a slight blur to the entire image.
SEPIA Nostalgic sepia	Adds a sepia tone and reduces the contrast to simulate the qualities of an old photograph.
 High-contrast mono.	Changes the image to black and white and gives it sharp contrast.
 Selective color	Creates a black and white image in which only the specified color remains.
POP Pop	Increases the color saturation of the entire image to create a bright look.
 Cross process	Gives the image a mysterious appearance based on a specific color.
 Toy camera effect 1	Gives the entire image a yellowish hue and darkens the image periphery.
 Toy camera effect 2	Decreases the color saturation of the entire image and darkens the image periphery.
Off (default setting)	Special effects are disabled.

- When **Selective color** or **Cross process** is selected, use the multi selector  to select the desired color, and press the  button to apply the color. To change the color selection, press the  button again.

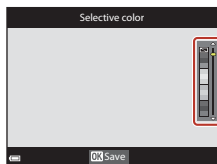

Operations During Movie Clip Playback

To adjust the volume, move the zoom control while a movie clip is playing (📖2).

Playback controls are displayed on the screen.

The operations described below can be performed by using the multi selector ◀▶ to select a control and then pressing the Ⓚ button.

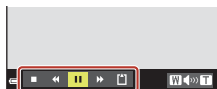

Playback controls

Function	Icon	Description	
Rewind	◀	Hold down the Ⓚ button to rewind the movie.	
Fast-forward	▶▶	Hold down the Ⓚ button to fast-forward the movie.	
Pause	⏸	Pause playback. The operations listed below can be performed while paused.	
		◀◀	Rewind the movie one frame. Hold down the Ⓚ button for continuous rewinding.
		▶▶	Advance the movie one frame. Hold down the Ⓚ button for continuous advancing.
		▶	Resume playback.
End playback	■	Return to the shooting screen.	
End recording	📺	Save the short movie show using the recorded movie clips.	

✓ Notes About Recording a Short Movie Show

- The camera cannot record movies if a memory card is not inserted.
- Do not exchange the memory card until a short movie show is saved.

📎 Pausing Movie Recording

- A still image with **Normal** in image quality and $\frac{16:9}{15M}$ 5184×2920 in image size can be captured if you press the shutter-release button with the shooting screen displayed while a movie is not being recorded.
- You can pause movie recording and play back images or enter other shooting modes to take pictures. Movie recording resumes when you enter 📺 (short movie show) mode again.

Functions Available in Short Movie Show Mode

- Self-timer (📖60)
- Macro mode (📖61)
- Exposure compensation (📖64)
- Movie options menu (📖112)



Operations During Movie Playback

To adjust the volume, move the zoom control while a movie is playing (📖2).

Rotate the multi selector or the command dial to fast-forward or rewind.

Playback controls are displayed on the screen.

The operations described below can be performed by using the multi selector ◀▶ to select a control and then pressing the Ⓚ button.



Volume indicator

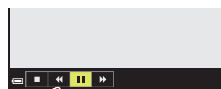

When paused

Function	Icon	Description	
Rewind	◀◀	Hold down the Ⓚ button to rewind the movie.	
Fast-forward	▶▶	Hold down the Ⓚ button to fast-forward the movie.	
Pause	⏸	Pause playback. The operations listed below can be performed while paused.	
		◀◀	Rewind the movie one frame. Hold down the Ⓚ button for continuous rewinding.*
		▶▶	Advance the movie one frame. Hold down the Ⓚ button for continuous advancing.*
		▶	Resume playback.
		📄	Extract the desired portion of a movie and save it as a separate file.
	🖼	Extract a single frame of a movie and save it as a still image.	
End	■	Return to full-frame playback mode.	

* The movie can also be advanced or rewound by one frame by rotating the multi selector or command dial.







Editing Movies

When editing movies, use a sufficiently charged battery to prevent the camera from turning off during editing. When the battery level indicator is , movie editing is not possible.



Extracting Only the Desired Portion of a Movie

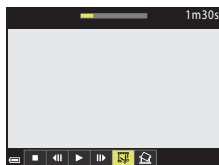

The desired portion of a recorded movie can be saved as a separate file.

1 Play back a desired movie and pause at the start point of the portion that you want to extract (98).

2 Use the multi selector  to select the  control, and then press the  button.





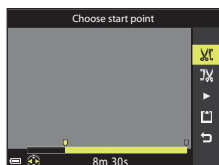

3 Use  to select  (choose start point).

- Use  or rotate the command dial to move the start point.
- To cancel editing, select , and press the  button.



4 Use  to select  (choose end point).

- Use  or rotate the command dial to move the end point.
- To preview the specified portion, use  to select  and then press the  button. Press the  button again to stop previewing.

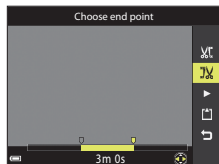

5 Use ▲▼ to select (save) and press the button.

- Follow the instructions on the screen to save the movie.

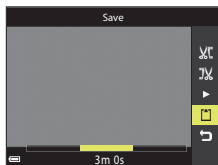





Notes About Movie Extracting



- A movie that was created by editing cannot be edited again.
- The actual trimmed portion of a movie may differ slightly from the portion selected using the start and end points.
- Movies cannot be trimmed so that they are less than two seconds long.

Saving a Frame from a Movie as a Still Image

The desired frame of a recorded movie can be extracted and saved as a still image.

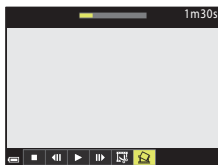

- Pause a movie and display the frame to be extracted (98).
- Use the multi selector  to select the  control and press the  button.

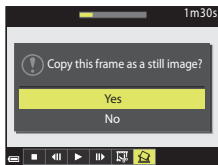

- Select **Yes** when a confirmation dialog is displayed, and press the  button to save the image.
- The still image is saved with **Normal** as the image quality. The image size is determined by the original movie image size (130).



Restrictions on Extracting Still Images

Still images cannot be extracted from a movie recorded with  **480/30p**,  **480/25p**, or HS movie option.



Connecting the Camera to a TV, Printer, or Computer

Utilizing Images	102
Viewing Images on a TV	103
Printing Images Without a Computer	104
Transferring Images to a Computer (ViewNX-i)	108



Utilizing Images

In addition to using the SnapBridge app to enjoy the captured images, you can also utilize the images in various ways by connecting the camera to the devices described below.

Viewing Images on a TV



Images and movies captured with the camera can be viewed on a TV. Connection method: Connect a commercially available HDMI cable to the TV's HDMI input jack.

Printing Images Without a Computer



If you connect the camera to a PictBridge-compatible printer, you can print images without using a computer. Connection method: Connect the camera directly to the printer's USB port with the USB cable.

Transferring Images to a Computer (ViewNX-i)



You can transfer images and movies to a computer for viewing and editing. Connection method: Connect the camera to the computer's USB port with the USB cable.

- Before connecting to a computer, install ViewNX-i on the computer.

✓ Notes About Connecting Cables to the Camera

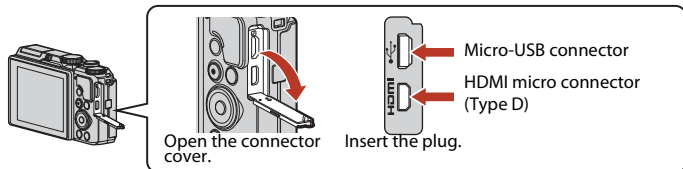

- Make sure to turn the camera off before connecting or disconnecting cables. Check the shape and direction of the plugs and do not insert or remove the plugs at an angle.
- Make sure that the camera battery is sufficiently charged. If the EH-62F AC Adapter (available separately) is used, this camera can be powered from an electrical outlet. Do not, under any circumstances, use an AC adapter other than the EH-62F. Failure to observe this precaution could result in overheating or damage to the camera.
- For information about the connection methods and subsequent operations, refer to the documentation included with the device in addition to this document.



Viewing Images on a TV

1 Turn off the camera and connect it to the TV.

- Check the shape and direction of the plugs and do not insert or remove the plugs at an angle.

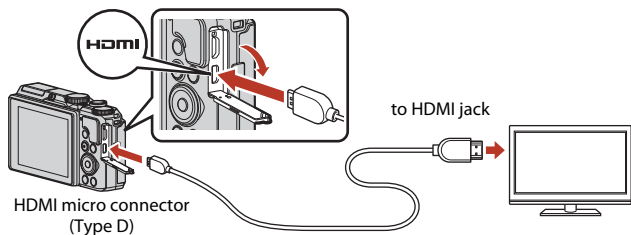

2 Set the TV's input to external input.

- See the documentation provided with your TV for details.

3 Press and hold down the (playback) button to turn on the camera.

- Images are displayed on the TV.
- The camera screen does not turn on.
- To play back movies that were saved using **2160 P 30p** (4K UHD) or **2160 P 25p** (4K UHD) in 4K UHD quality, use a TV and HDMI cable that support 4K.

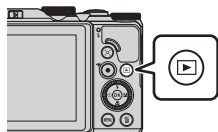

Printing Images Without a Computer

Users of PictBridge-compatible printers can connect the camera directly to the printer and print images without using a computer.

Connecting the Camera to a Printer

- 1 Turn on the printer.
- 2 Turn off the camera and connect it to the printer using the USB cable.
 - Check the shape and direction of the plugs and do not insert or remove the plugs at an angle.

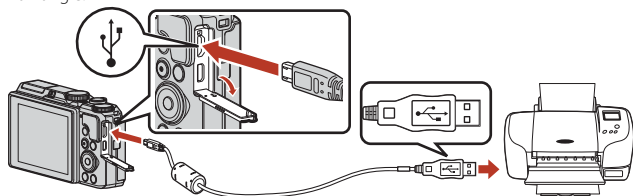

- 3 The camera is automatically turned on.
 - The **PictBridge** startup screen (①) is displayed on the camera screen, followed by the **Print selection** screen (②).

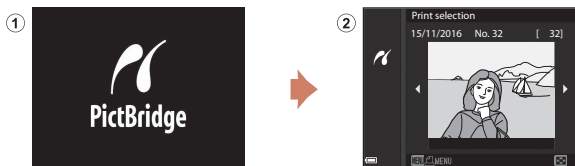

✓ If the PictBridge Startup Screen Is Not Displayed

When **Auto** is selected for **Charge by computer** (157), it may be impossible to print images with direct connection of the camera to some printers.

If the PictBridge startup screen is not displayed after the camera is turned on, turn the camera off and disconnect the USB cable. Set **Charge by computer** to **Off** and reconnect the camera to the printer.



Printing Images One at a Time

1 Use the multi selector ◀▶ to select the desired image and press the **OK** button.

- Move the zoom control toward **W** (📐) to switch to thumbnail playback or **T** (📺) to switch to full-frame playback.

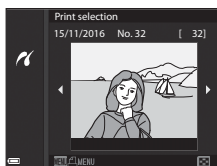

2 Use ▲▼ to select **Copies** and press the **OK** button.

- Use ▲▼ to set the desired number of copies (up to nine) and press the **OK** button.

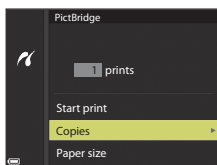

3 Select **Paper size** and press the **OK** button.

- Select the desired paper size and press the **OK** button.
- To print with the paper size setting configured on the printer, select **Default**.
- The paper size options available on the camera vary depending on the printer that you use.

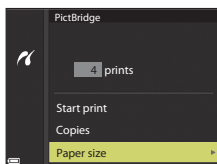

4 Select **Start print** and press the **OK** button.

- Printing starts.

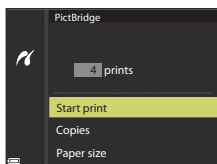

Printing Multiple Images

- 1 When the **Print selection** screen is displayed, press the **MENU** (menu) button.

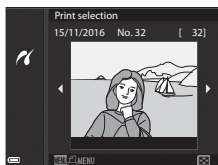

- 2 Use the multi selector ▲▼ to select **Paper size** and press the **OK** button.
 - Select the desired paper size and press the **OK** button.
 - To print with the paper size setting configured on the printer, select **Default**.
 - The paper size options available on the camera vary depending on the printer that you use.
 - To exit the print menu, press the **MENU** button.

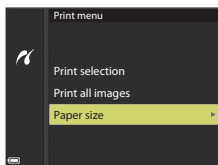

- 3 Select **Print selection** or **Print all images** and press the **OK** button.

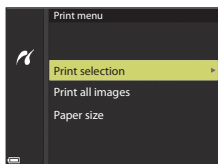

Print selection

Select images (up to 99) and the number of copies (up to 9) of each.

- Use the multi selector ◀▶ to select images, and use ▲▼ to specify the number of copies to be printed.
- Images selected for printing are indicated by  and the number of copies to be printed. To cancel the print selection, set the number of copies to 0.
- Move the zoom control toward **T** (🔍) to switch to full-frame playback or **W** (🖼️) to switch to thumbnail playback.
- Press the **OK** button when setting is complete. When the screen for confirming the number of print copies is displayed, select **Start print** and press the **OK** button to start printing.

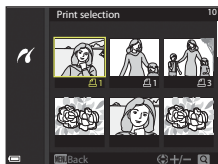

Print all images

One copy each of all images saved in the internal memory, or on the memory card is printed.

- When the screen for confirming the number of print copies is displayed, select **Start print** and press the **OK** button to start printing.



Transferring Images to a Computer (ViewNX-i)

Installing ViewNX-i

ViewNX-i is free software that enables you to transfer images and movies to your computer for viewing and editing.

To install ViewNX-i, download the latest version of the ViewNX-i installer from the following website and follow the on-screen instructions to complete installation.

<http://downloadcenter.nikonimglib.com>

For system requirements and other information, see the Nikon website for your region.

Transferring Images to a Computer

1 Prepare a memory card that contains images.

You can use any of the methods below to transfer images from the memory card to a computer.

- **SD memory card slot/card reader:** Insert the memory card into the card slot of your computer or the card reader (commercially available) that is connected to the computer.
- **Direct USB connection:** Turn the camera off and ensure that the memory card is inserted in the camera. Connect the camera to the computer using the USB cable. The camera automatically turns on.

To transfer images that are saved in the camera's internal memory, remove the memory card from the camera before connecting it to the computer.

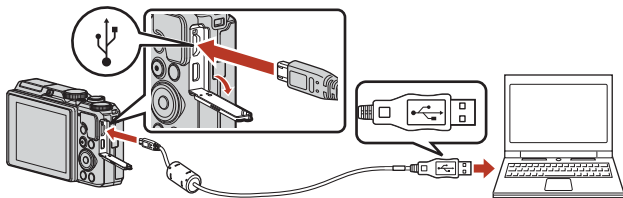

✓ Notes About Connecting the Camera to a Computer

Disconnect all other USB-powered devices from the computer. Connecting the camera and other USB-powered devices to the same computer simultaneously may cause a camera malfunction or excessive power supply from the computer, which could damage the camera or memory card.



If a message is displayed prompting you to choose a program, select Nikon Transfer 2.

- **When using Windows 7**

If the dialog shown on the right is displayed, follow the steps below to select Nikon Transfer 2.

- 1 Under **Import pictures and videos**, click **Change program**. A program selection dialog will be displayed; select Nikon Transfer 2 and click **OK**.
- 2 Double-click Nikon Transfer 2 icon.

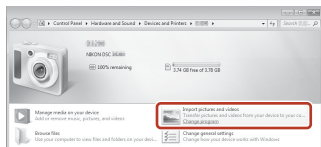

- **When using Windows 10 or Windows 8.1**

If the dialog shown on the right is displayed, click the dialog and then click **Import File/Nikon Transfer 2**.

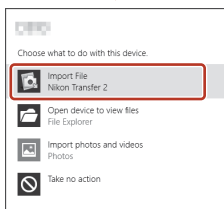

- **When using OS X or macOS**

If Nikon Transfer 2 does not automatically start, launch the **Image Capture** application that comes bundled with Mac while the camera and your computer are connected, and select Nikon Transfer 2 as the default application to open when the camera is connected to your computer.

If the memory card contains a large number of images, it may take a while for Nikon Transfer 2 to start. Wait until Nikon Transfer 2 starts.

Notes About Connecting the USB Cable

Operation is not guaranteed if the camera is connected to the computer via a USB hub.

Using ViewNX-i

Consult online help for more information.



2 After Nikon Transfer 2 starts, click **Start Transfer**.

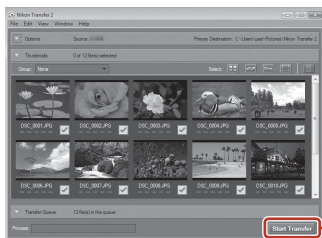

- Image transfer begins. When image transfer is complete, ViewNX-i starts and the transferred images are displayed.

3 Terminate the connection.

- If you are using a card reader or card slot, choose the appropriate option in the computer operating system to eject the removable disk corresponding to the memory card and then remove the memory card from the card reader or card slot.
- If the camera is connected to the computer, turn the camera off and disconnect the USB cable.







Using the Menu

Menu Operations.....	112
Menu Lists	115
The Shooting Menu (The Common Shooting Options)	118
The Shooting Menu (P, S, A, or M Mode).....	120
The Movie Menu	130
The Playback Menu.....	138
The Network Menu	143
The Setup Menu.....	145



Menu Operations

You can set the menus listed below by pressing the **MENU** (menu) button.

-  Shooting menu^{1, 2}
-  Movie menu¹
- **MODE Playback mode menu (List by date mode)**³
-  Playback menu³
-  Network menu
-  Setup menu

¹ Press the **MENU** button when the shooting screen is displayed.

² Menu icons and available setting options vary depending on the shooting mode.

³ Press the **MENU** button when the playback screen is displayed.

1 Press the **MENU** (menu) button.

- The menu is displayed.

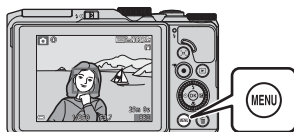

2 Press the multi selector .

- The current menu icon is displayed in yellow.

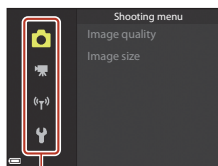

Menu icons

3 Select a menu icon and press the **OK** button.

- The menu options become selectable.

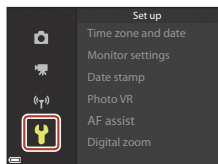

4 Select a menu option and press the **OK** button.

- Certain menu options cannot be set depending on the current shooting mode or the state of the camera.

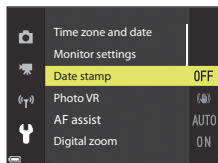

5 Select a setting and press the **OK** button.

- The setting you selected is applied.
- When you are finished using the menu, press the **MENU** button.
- When a menu is displayed, you can switch to shooting mode by pressing the shutter-release button or **(P/)** button.

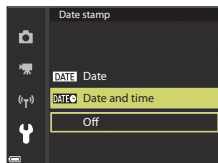

Command Dial or Multi Selector Operation When a Menu is Displayed

When a menu or setting items are displayed, you can select a menu option also by rotating the command dial or multi selector.



The Image Selection Screen

When an image selection screen such as the one shown on the right is displayed while operating the camera menu, follow the procedures described below to select the images.



1 Use the multi selector ◀▶ or rotate it to select the desired image.

- Move the zoom control (📖2) toward **T** (📺) to switch to full-frame playback, or **W** (📷) to switch to thumbnail playback.
- Only one image can be selected for **Rotate image**. Proceed to step 3.

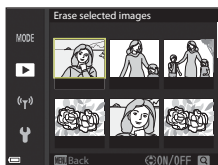

2 Use ▲▼ to select **ON** or **OFF**.

- When **ON** is selected, an icon is displayed under the selected image. Repeat steps 1 and 2 to select additional images.

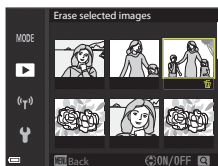

3 Press the **OK** button to apply the image selection.

- When a confirmation dialog is displayed, follow the on-screen instructions to operate.



Menu Lists

The Shooting Menu

Enter shooting mode → MENU button

Common Options



Option	Default setting	
Image quality	Normal	118
Image size	20M 5184×3888	119

For P, S, A, and M Modes

Option	Default setting	
White balance	Auto	120
Metering	Matrix	122
Continuous	Single	123
ISO sensitivity	Auto	125
AF area mode	Target finding AF	126
Autofocus mode	Pre-focus	129
M exposure preview	On	129

The Movie Menu

Enter shooting mode → MENU button →  menu icon →  button

Option	Default setting	
Movie options	 1080/30p or  1080/25p	130
AF area mode	Face priority	134
Autofocus mode	Single AF	135
Movie VR	On (hybrid)	136
Wind noise reduction	Off	137



Option	Default setting	
Frame rate	–	137

The Playback Menu

Press the  button (playback mode) → MENU button

Option	
Mark for upload ¹	138
Quick retouch ²	82
D-Lighting ²	82
Red-eye correction ²	83
Glamour retouch ²	83
Slide show	139
Protect ¹	140
Rotate image ¹	140
Small picture ²	85
Copy ¹	141
Sequence display	142

¹ Select an image on the image selection screen. See “The Image Selection Screen” ( 114) for more information.

² Edited images are saved as separate files. Some images may not be edited.

The Network Menu

Press the MENU button →  menu icon →  button

Option	
Airplane mode	143
Connect to smart device	143
Send while shooting	143
Wi-Fi	143



Option	
Bluetooth	143
Restore default settings	143

The Setup Menu

Press the **MENU** button →  menu icon →  button

Option	
Time zone and date	145
Monitor settings	147
Date stamp	149
Photo VR	150
AF assist	151
Digital zoom	151
Sound settings	152
Auto off	152
Format card/Format memory	153
Language	153
Image comment	154
Copyright information	155
Location data	156
Charge by computer	157
Reset all	158
Conformity marking	158
Firmware version	158



The Shooting Menu (The Common Shooting Options)

Image Quality

Enter shooting mode* → MENU button → Image quality →  button

* The image quality can be set in shooting modes other than the short movie show mode. The setting is also applied to other shooting modes (except **Time-lapse movie**, **Superlapse movie**, and **Easy panorama** scene modes).

Set the image quality (compression ratio) used when saving images.

Lower compression ratios result in higher quality images, but the number of images that can be saved is reduced.

Option	Description
FINE Fine	Finer image quality than Normal . Compression ratio of about 1:4
NORM Normal (default setting)	Normal image quality, suitable for most applications. Compression ratio of about 1:8

Notes About Image Quality

This function may not be available to use in combination with other functions (73).

Number of Images That Can Be Saved

- The approximate number of images that can be saved can be checked on the screen when shooting (17).
- Note that due to JPEG compression, the number of images that can be saved may vary greatly depending on the image content, even when using memory cards with the same capacity and the same image quality and image size settings. In addition, the number of images that can be saved may vary depending on the make of the memory card.
- If the number of exposures remaining is 10,000 or more, the number of exposures remaining display shows "9999."









Image Size

Enter shooting mode* → MENU button → Image size → OK button

* The image size can be set in shooting modes other than the short movie show mode. The setting is also applied to other shooting modes (except **Time-lapse movie**, **Superlapse movie**, and **Easy panorama** scene modes).

Set the image size (number of pixels) used when saving images.

The larger the image size, the larger the size at which it can be printed, but the number of images that can be saved is reduced.

Option*	Aspect ratio (horizontal to vertical)
 5184×3888 (default setting)	4:3
 3648×2736	4:3
 2272×1704	4:3
 1600×1200	4:3
 640×480	4:3
 5184×2920	16:9
 3888×3888	1:1

* The numerical values indicate the number of pixels that are captured.
Example:  **5184×3888** = approx. 20 megapixels, 5184 × 3888 pixels

Notes About Printing Images at 1:1 Aspect Ratio

Change the printer setting to “Border” when printing images at a 1:1 aspect ratio. Some printers may not be able to print images at a 1:1 aspect ratio.

Notes About Image Size

This function may not be available to use in combination with other functions (73).







The Shooting Menu (P, S, A, or M Mode)

- See “Image Quality” (📖118) and “Image Size” (📖119) for information about **Image quality** and **Image size**.

White Balance (Adjusting Hue)

Rotate the mode dial to P, S, A, or M → MENU button → P, S, A, or M menu icon → White balance →  button

Adjust white balance to suit the light source or weather conditions in order to make the colors in images match what you see with your eyes.

Option	Description
AUTO Auto (default setting)	White balance is automatically adjusted.
PRE Preset manual	Use when the desired result is not achieved with Auto , Incandescent , etc. (📖121).
 Daylight	Use under direct sunlight.
 Incandescent	Use under incandescent lighting.
 Fluorescent	Use under fluorescent lighting.
 Cloudy	Use under overcast skies.
 Flash	Use with the flash.

Notes About White Balance

- Lower the flash when white balance is set to any setting other than **Auto** and **Flash** (📖19).
- This function may not be available to use in combination with other functions (📖73).



Using Preset Manual

Follow the procedures described below to measure the white balance value under the lighting used during shooting.

1 Place a white or gray reference object under the lighting that will be used during shooting.

2 Use the multi selector ▲▼ to select **Preset manual**, and press the **OK** button.

- The lens extends to the zoom position for measurement.

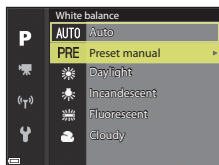

3 Select **Measure**.

- To apply the last measured value, select **Cancel** and press the **OK** button.

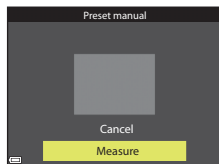

4 Frame the white or gray reference object in the measuring window, and press the **OK** button to measure the value.

- The shutter is released and measurement is complete (no image is saved).

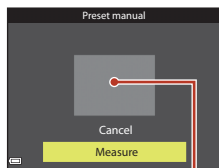

Measuring window

✓ Notes About Preset Manual

A white balance value for flash lighting cannot be measured with **Preset manual**. When shooting using the flash, set **White balance** to **Auto**, or **Flash**.





Metering

Rotate the mode dial to **P, S, A, or M** → **MENU** button → **P, S, A, or M** menu icon → Metering → 

The process of measuring the brightness of the subject to determine the exposure is known as "metering."

Use this option to set the method of how the camera meters exposure.

Option	Description
 Matrix (default setting)	The camera uses a wide area of the screen for metering. Recommended for typical shooting.
 Center-weighted	The camera meters the entire frame but assigns greatest weight to the subject in the center of the frame. The classic metering for portraits; it preserves background details while letting lighting conditions in the center of the frame determine exposure. Can be used with focus lock ( 70) to set focus and exposure for off-center subjects.

Notes About Metering

- When digital zoom is in effect, **Center-weighted** or spot metering (where the center of the frame is metered) is selected depending on the zoom ratio.
- This function may not be available to use in combination with other functions (73).











Display on the Shooting Screen

When **Center-weighted** is selected, the metering range guide (4) is displayed (except when digital zoom is used).



Continuous Shooting

Rotate the mode dial to **P, S, A, or M** → **MENU** button → **P, S, A, or M** menu icon → **Continuous** → **OK** button

Option	Description
 Single (default setting)	One image is captured each time the shutter-release button is pressed.
 Continuous H	While the shutter-release button is held all the way down, images are captured continuously. <ul style="list-style-type: none"> The camera can capture up to about 7 images continuously at a rate of about 7 fps (when set to Normal (image quality) and 20M 5184×3888 (image size)).
 Continuous L	While the shutter-release button is held all the way down, images are captured continuously. <ul style="list-style-type: none"> The camera can capture up to about 15 images continuously at a rate of about 2.2 fps (when set to Normal (image quality) and 20M 5184×3888 (image size)). If the shutter-release button is held all the way down further, the frame rate becomes slower.
 Pre-shooting cache	Pre-shooting cache shooting begins when the shutter-release button is pressed halfway. When the shutter-release button is pressed all the way down, the camera saves the current image as well as the images captured immediately before the button is pressed ( 124). Pre-shooting cache makes it easy to capture perfect moments. <ul style="list-style-type: none"> The camera can capture up to about 25 images continuously at a rate of about 15 fps (including a maximum of 5 images captured in the pre-shooting cache). The image quality is fixed at Normal and the image size is fixed at  (1280 × 960 pixels).
 Continuous H: 120 fps	Each time the shutter-release button is pressed all the way down, images are captured continuously at a high speed rate. <ul style="list-style-type: none"> The camera can capture up to about 50 images continuously at a rate of about 120 fps. The image quality is fixed at Normal and the image size is fixed at  640×480.
 Continuous H: 60 fps	Each time the shutter-release button is pressed all the way down, images are captured continuously at a high speed rate. <ul style="list-style-type: none"> The camera can capture up to about 25 images continuously at a rate of about 60 fps. The image quality is fixed at Normal and the image size is fixed at  (1280 × 960 pixels).



✓ Notes About Continuous Shooting

- Focus, exposure and white balance are fixed at the values determined with the first shot in each series.
- It may take some time to save the images after shooting.
- When ISO sensitivity increases, noise may appear in captured images.
- The frame rate may become slower depending on the image quality, image size, memory card type or shooting conditions.
- When using **Pre-shooting cache**, **Continuous H: 120 fps**, or **Continuous H: 60 fps**, banding or variance in brightness or hue may occur in images that were captured under lighting that flashes quickly at high speeds, such as fluorescent, mercury-vapor, or sodium-vapor lighting.
- This function may not be available to use in combination with other functions (📖73).

📎 Pre-shooting Cache

When the shutter-release button is pressed halfway or all the way down, images are saved as described below.

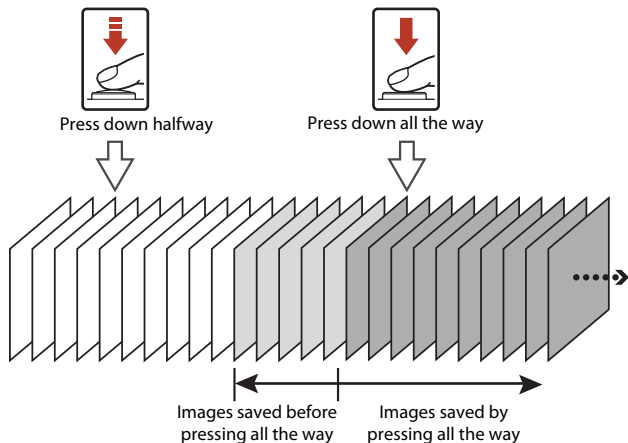

- The pre-shooting cache icon (📎) on the shooting screen changes to green while the shutter-release button is pressed halfway.



ISO Sensitivity

Rotate the mode dial to **P, S, A, or M** → **MENU** button → **P, S, A, or M** menu icon → ISO sensitivity → **OK** button

A higher ISO sensitivity allows darker subjects to be captured. Additionally, even with subjects of similar brightness, pictures can be taken at faster shutter speeds, and blurring caused by camera shake and subject movement can be reduced.

- When a higher ISO sensitivity is set, images may contain noise.

Option	Description
AUTO Auto (default setting)	Sensitivity is automatically selected from the range of ISO 80 to 1600.
ISO AUTO Fixed range auto	The range in which the camera automatically adjusts ISO sensitivity can be selected from ISO 80-400 or ISO 80-800 .
80, 100, 200, 400, 800, 1600, 3200	ISO sensitivity is fixed at the specified value.

Notes About ISO Sensitivity

- In **M** (manual) mode, when set to **Auto, ISO 80-400, or ISO 80-800**, the ISO sensitivity is fixed at ISO 80.
- This function may not be available to use in combination with other functions (📖73).

ISO Sensitivity Display on the Shooting Screen



- When **Auto** is selected, **ISO** is displayed when the ISO sensitivity increases.
- When **Fixed range auto** is selected, the maximum value for ISO sensitivity is displayed.



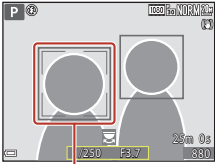
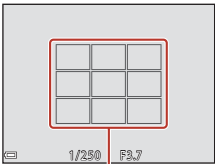

AF Area Mode

Rotate the mode dial to **P**, **S**, **A** or **M** → **MENU** button → **P**, **S**, **A** or **M** menu icon → AF area mode → **OK** button

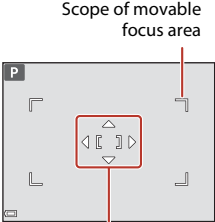
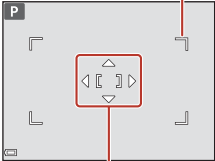
Set how the camera selects the focus area for autofocus when shooting still images.

Option	Description
<p> Face priority</p>	<p>When the camera detects a human face, it focuses on that face. See “Using Face Detection” (p.68) for more information.</p> <p>When framing a composition with no human subjects or detected faces, the camera automatically selects one or more of the nine focus areas containing the subject closest to the camera when the shutter-release button is pressed halfway.</p> <div style="display: flex; justify-content: space-between; align-items: center;"> <div data-bbox="671 316 951 526">  <p data-bbox="697 539 809 563">Focus area</p> </div> <div data-bbox="671 571 951 782">  <p data-bbox="738 798 850 821">Focus area</p> </div> </div>
<p> Manual</p>	<p>Use the multi selector  to move the focus area to where you want to focus.</p> <p>To use the multi selector to configure the flash mode or other settings, press the OK button. To return to moving the focus area, press the OK button again.</p> <div style="display: flex; justify-content: space-between; align-items: center;"> <div data-bbox="671 850 951 1137">  <p data-bbox="749 850 935 898">Scope of movable focus area</p> </div> <div data-bbox="671 930 951 1137">  <p data-bbox="738 1161 850 1185">Focus area</p> </div> </div>

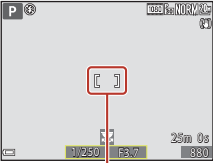

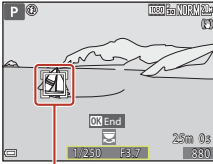
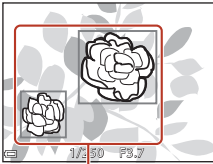
Option	Description
<p>[] Center</p>	<p>The camera focuses on the subject in the center of the frame.</p>  <p>The image shows a camera viewfinder with a red square focus area centered on the frame. The viewfinder displays 'P' mode, '1/250 F3.7', '25m 0s', and '880'.</p> <p style="text-align: center;">Focus area</p>
<p> Subject tracking</p>	<p>Use this function to take pictures of moving subjects. Register the subject on which the camera focuses. The focus area automatically moves to track the subject. See "Using Subject Tracking" (📖128) for more information.</p>  <p>The image shows a camera viewfinder with a red square focus area tracking a subject (a boat). The viewfinder displays 'P' mode, '1/250 F3.7', '25m 0s', and '880'. An 'OK End' button is visible.</p> <p style="text-align: center;">Focus area</p>
<p>[] Target finding AF (default setting)</p>	<p>When the camera detects the main subject, it focuses on that subject. See "Using Target Finding AF" (📖67) for more information.</p>  <p>The image shows a camera viewfinder with a red square focus area on a flower. A smaller red square focus area is also visible on a smaller flower in the background. The viewfinder displays '1/250 F3.7'.</p> <p style="text-align: center;">Focus areas</p>

Notes About AF Area Mode

- When digital zoom is in effect, the camera focuses on the area in the center of the frame regardless of the **AF area mode** setting.
- This function may not be available to use in combination with other functions (📖73).

AF Area Mode for Movie Recording



AF area mode for movie recording can be set with **AF area mode** (📖134) in the movie menu.



Using Subject Tracking

Rotate the mode dial to P, S, A or M → MENU button → P, S, A or M menu icon → AF area mode → OK button →  Subject tracking → OK button → MENU button

1 Register a subject.

- Align the subject that you want to track with the border in the center of the frame and press the  button.
- When the subject is registered, a yellow border (focus area) is displayed around it and the camera begins tracking the subject.
- If the subject cannot be registered, the border is displayed in red. Change the composition and try registering the subject again.
- To cancel subject registration, press the  button.
- If the camera can no longer track the registered subject, the focus area disappears. Register the subject again.

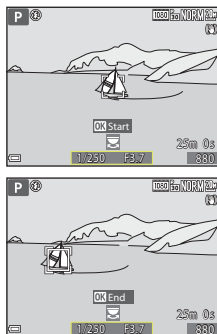

2 Press the shutter-release button all the way to take the picture.

- If the shutter-release button is pressed while the focus area is not displayed, the camera focuses on the subject in the center of the frame.

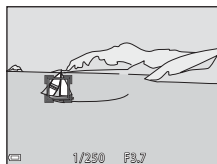

Notes About Subject Tracking

- If you perform operations such as zooming while the camera is tracking the subject, the registration is canceled.
- Subject tracking may not be possible in certain shooting conditions.



Autofocus Mode

Rotate the mode dial to **P**, **S**, **A** or **M** → **MENU** button → **P**, **S**, **A** or **M** menu icon → Autofocus mode → 

Set how the camera focuses when shooting still images.

Option	Description
AF-S Single AF	The camera focuses only when the shutter-release button is pressed halfway.
AF-F Full-time AF	The camera always focuses even if the shutter-release button is not pressed halfway. The sound of lens drive movement is heard while the camera focuses.
PRE-AF Pre-focus (default setting)	Even if the shutter-release button is not pressed halfway, the camera focuses when subject movement is detected or when the composition of the framed image is significantly changed.

Notes About Autofocus Mode

This function may not be available to use in combination with other functions (73).

Autofocus Mode for Short Movie Show Mode or Movie Recording

Autofocus mode for short movie show mode or movie recording can be set with **Autofocus mode** (135) in the movie menu.

M Exposure Preview

Rotate the mode dial to **P**, **S**, **A** or **M** → **MENU** button → **P**, **S**, **A** or **M** menu icon → M exposure preview → 



Set whether or not to reflect the brightness to the shooting screen when the exposure is changed in **M** (manual) mode.



Option	Description
On (default setting)	Reflects the brightness to the shooting screen.
Off	Does not reflect the brightness to the shooting screen.





The Movie Menu











Movie Options

Enter shooting mode → MENU button →  menu icon → Movie options →  button



Select the desired movie option to record. Select normal speed movie options to record at normal speed, or HS movie options () 131) to record in slow or fast motion. The movie options that can be selected vary depending on the **Frame rate** setting () 137).

- Cards rated Speed Class 6 or better are recommended for movie recording () 188). When **Movie options** is set to  **2160/30p** (4K UHD) or  **2160/25p** (4K UHD), cards rated UHS Speed Class 3 or better are recommended.

Normal Speed Movie Options

Option (Image size/ Frame rate, File format)	Image size	Aspect ratio (horizontal to vertical)	Maximum recording time (approx.)
 2160/30p  2160/25p (4K UHD)	3840 × 2160	16:9	7 min 8 min
 1080/30p  1080/25p (default setting)	1920 × 1080	16:9	26 min
 1080/60p  1080/50p	1920 × 1080	16:9	13 min
 720/30p  720/25p	1280 × 720	16:9	29 min
 480/30p  480/25p	640 × 480	4:3	29 min

Notes About Movie Options



When time-lapse movie or superlapse movie is selected in scene mode, movie option is fixed at  **1080/30p** or  **1080/25p**.



HS Movie Options

Recorded movies are played back in fast or slow motion.

See "Recording Movies in Slow Motion and Fast Motion (HS Movie)" (📖133).

Option	Image size Aspect ratio (horizontal to vertical)	Description
 HS 480/4x	640 × 480 4:3	1/4-speed slow motion movies <ul style="list-style-type: none">• Max. recording time*: 15 seconds (playback time: 1 minute)
 HS 1080/0.5x	1920 × 1080 16:9	2x speed fast motion movies <ul style="list-style-type: none">• Max. recording time*: 2 minutes (playback time: 1 minute)

* While recording movies, the camera can be switched between normal speed movie recording and slow motion or fast motion movie recording. The maximum recording time shown here refers only to the portion of the movie that is recorded in slow motion or fast motion.

Notes About HS Movie

- Sound is not recorded.
- Zoom position, focus, exposure, and white balance are locked when movie recording starts.



Playing Back in Slow Motion and Fast Motion

When recording at normal speed:

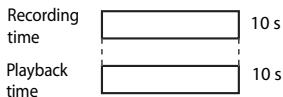

When recording at $\frac{480}{120}$ HS 480/4x, or $\frac{480}{100}$ HS 480/4x:

Movies are recorded at 4x normal speed.

They are played back in slow motion at 4x slower speed.

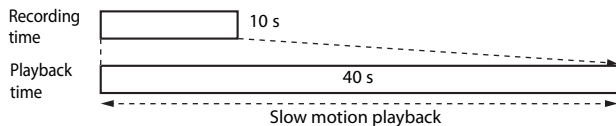



When recording at $\frac{1080}{120}$ HS 1080/0.5x, or $\frac{1080}{100}$ HS 1080/0.5x:

Movies are recorded at 1/2 normal speed.

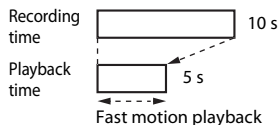

They are played back in fast motion at 2x faster speed.



Recording Movies in Slow Motion and Fast Motion (HS Movie)

Enter shooting mode → MENU button →  menu icon → Movie options →  button



Movies recorded using HS movie can be played back in slow motion at 1/4 of the normal playback speed, or in fast motion at twice the normal playback speed.

1 Use the multi selector  to select an HS movie option ( 131) and press the  button.

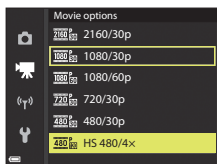
- After applying the option, press the MENU button to return to the shooting screen.



2 Press the  (movie-record) button to start recording.

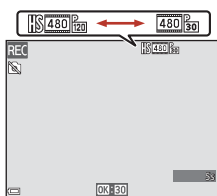

- The camera switches between normal speed movie recording and HS movie recording each time the  button is pressed.
- The movie options icon changes when switching between HS movie recording and normal speed movie recording.
- When the maximum recording time for HS movies ( 131) is reached, the camera automatically switches to normal speed movie recording.





3 Press the  button to end recording.



AF Area Mode

Enter shooting mode → MENU button →  menu icon → AF area mode →  button

Set how the camera selects the focus area for autofocus in superlapse movie, short movie show mode, or when recording movies.

Option	Description
 Face priority (default setting)	When the camera detects a human face, it focuses on that face. See "Using Face Detection" (📖68) for more information.
 Center	The camera focuses on the subject in the center of the frame.

Notes About AF Area Mode for Movie Recording

AF area mode is set to focus on the center in the following situations even when **Face priority** is selected.

- When **Autofocus mode** in the movie menu is set to **Single AF** and no faces are detected before pressing the  button.
- When an HS movie option is selected in **Movie options**.



Autofocus Mode

Enter shooting mode → MENU button →  menu icon → Autofocus mode →  button

Set how the camera focuses in superlapse movie, short movie show mode, or when recording movies.

Option	Description
AF-S Single AF (default setting)	Focus is locked when movie recording starts. Select this option when the distance between the camera and the subject will remain fairly consistent.
AF-F Full-time AF	The camera focuses continuously. Select this option when the distance between the camera and subject will change significantly during recording. The sound of the camera focusing may be heard in the recorded movie. Use of Single AF is recommended to prevent the sound of the camera focusing from interfering with recording.

Notes About Autofocus Mode

- When an HS movie option is selected in **Movie options**, the setting is fixed at **Single AF**.
- This function may not be available to use in combination with other functions.





Movie VR



Enter shooting mode → MENU button →  menu icon → Movie VR →  button

Set to reduce the effects of camera shake in short movie show mode or when recording movies.

Set this option to **Off** when using a tripod to stabilize the camera during recording.



Option	Description
 ★ On (hybrid) (default setting)	Performs optical compensation for camera shake using the lens shift method. Also performs electronic VR using image processing. The angle of view (i.e., the area visible in the frame) becomes narrower.
 On	Compensates for camera shake using the lens shift method.
Off	Compensation is not performed.

Notes About Movie VR

- When  **2160/30p** (4K UHD) or  **2160/25p** (4K UHD), or HS movie option is selected in **Movie options**, **On (hybrid)** cannot be selected.
- When **Superlapse movie** is selected, the setting is fixed at **On (hybrid)**.
- The effects of camera shake may not be completely eliminated in some situations.



Wind Noise Reduction

Enter shooting mode → MENU button →  menu icon → Wind noise reduction →  button



Option	Description
 On	Reduces the sound that is produced when wind passes over the microphone during movie recording. Other sounds may become difficult to hear during playback.
Off (default setting)	Wind noise reduction is disabled.

Notes About Wind Noise Reduction

The setting is fixed at **Off** in the following situations:

- In superlapse movies
- When an HS movie option is selected in **Movie options**.

Frame Rate

Enter shooting mode → MENU button →  menu icon → Frame rate →  button

Select the frame rate used in time-lapse movie, superlapse movie, short movie show mode, or when recording movies. When the frame rate setting is switched, options that can be set in **Movie options** ( 130) change.



Option	Description
30 fps (30p/60p)	Suited for playback on a TV using the NTSC standard.
25 fps (25p/50p)	Suited for playback on a TV using the PAL standard.



The Playback Menu

See “Editing Images (Still Images)” (📖81) for information about image editing functions.

Mark for upload

Press the  button (playback mode) → MENU button → Mark for upload →  button

Select still images in the camera and upload them to a smart device that has a wireless connection established with the SnapBridge app.

On the image selection screen (📖114), select or deselect images for the Mark for upload function.

- The size of images that are uploaded is restricted to 2 megapixels. To upload still images at their original size, use **Download pictures** in the SnapBridge app.
- Movies cannot be selected for upload. To upload movies to a smart device, use **Download pictures** in the SnapBridge app.
- Note that when you select **Reset all** (📖158) in the setup menu or **Restore default settings** (📖143) in the Network menu, the Mark for upload settings that you made are canceled.





Slide Show

Press the  button (playback mode) → MENU button → Slide show →  button



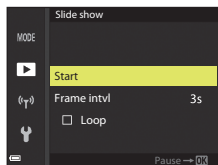

Play back images one by one in an automated “slide show.” When movie files are played back in the slide show, only the first frame of each movie is displayed.

1 Use the multi selector to select **Start** and press the button.

- The slide show begins.
- To change the interval between images, select **Frame intvl**, press the  button, and specify the desired interval time before selecting **Start**.
- To repeat the slide show automatically, select **Loop** and press the  button before selecting **Start**.
- The maximum playback time is up to about 30 minutes even if **Loop** is enabled.







2 End or restart the slide show.

- The screen shown on the right is displayed after the slide show ends or is paused. To exit the show, select  and then press the  button. To resume the slide show, select  and then press the  button.





Operations During Playback

- Use the multi selector   to display the previous/next image. Press and hold down   to rewind/fast-forward images quickly.
- Press the  button to pause or end the slide show.



Protect



Press the  button (playback mode) → MENU button → Protect →  button

The camera protects selected images from accidental deletion.

Select images to protect or cancel protection from the image selection screen (114).

Note that formatting the memory card or the camera's internal memory permanently deletes all data including protected files (153).

Rotate Image

Press the  button (playback mode) → MENU button → Rotate image →  button

Specify the orientation in which saved images are displayed during playback. Still images can be rotated 90 degrees clockwise or 90 degrees counterclockwise. Images that were saved in the "tall" orientation can be rotated up to 180 degrees in either direction.

Select an image from the image selection screen (114). When the rotate image screen is displayed, use the multi selector  or rotate it to rotate the image 90 degrees.



Rotate 90 degrees
counterclockwise

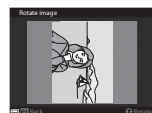



Rotate 90 degrees
clockwise

Press the  button to finalize display orientation, and save orientation information with the image.





Copy (Copy Between the Memory Card and Internal Memory)

Press the  button (playback mode) → MENU button → Copy →  button

Images can be copied between a memory card and the internal memory.

- When a memory card that contains no images is inserted and the camera is switched to playback mode, **Memory contains no images.** is displayed. In that case, press the MENU button to select **Copy**.

- 1 Use the multi selector   to select a destination option to which images are copied and press the  button.

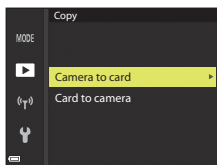

- 2 Select a copy option and press the  button.

- When you choose the **Selected images**, use the image selection screen to specify images (114).
- If you choose the **Card to camera** option, the All images option is not available.

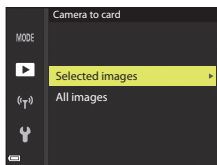

Notes About Copying Images



- Only files in formats that this camera can record can be copied.
- Operation is not guaranteed with images captured with another make of camera or that have been modified on a computer.

Copying Images in a Sequence



- If you select a key picture of a sequence in **Selected images**, all images in the sequence are copied.
- If you press the MENU button while images in a sequence are displayed, only the **Card to camera** copy option is available. All images in the sequence are copied if you select **Current sequence**.



Sequence Display

Press the  button (playback mode) → MENU button → Sequence display →  button

Select the method used to display images in the sequence (79).

Option	Description
 Individual pictures	Displays each image in a sequence individually.  is displayed on the playback screen.
 Key picture only (default setting)	Displays only the key picture for images in a sequence.

Settings are applied to all sequences, and the setting is saved in the camera's memory even after the camera is turned off.





The Network Menu

Press the **MENU** button →  menu icon →  button

Configure the wireless network settings to connect the camera and a smart device.

- Some settings cannot be changed while a wireless connection is established. To change them, disconnect the wireless connection.

Option	Description	
Airplane mode	Select On to turn off all wireless connections.	
Connect to smart device	Select when using the SnapBridge app to connect the camera and a smart device ( 25).	
Send while shooting	Set the conditions for automatically sending images to a smart device. <ul style="list-style-type: none">• The size of images that are uploaded is restricted to 2 megapixels. To upload still images at their original size, use Download pictures in the SnapBridge app.	
Wi-Fi	Network settings	SSID* : Change the SSID. Set a 1- to 32-character alphanumeric SSID.
		Auth./encryp.: Select whether or not to encrypt the communications between the camera and the connected smart device. Communications are not encrypted when Open is selected.
		Password* : Set the password. Set an 8- to 36-character alphanumeric password.
		Channel: Select the channel used for wireless connections.
		Subnet mask: Use the default setting (255.255.255.0) under normal conditions.
		DHCP server IP address: Use the default setting (192.168.0.10) under normal conditions.
	Current settings Display the current settings.	
Bluetooth	Connection	Select Disable to turn off Bluetooth communication.
	Paired devices	Change the smart device to connect with, or delete the connected smart device. This camera can be paired with up to five smart devices, but can connect to only one device at a time.
	Send while off	Set whether or not to allow the camera to communicate with the smart device when the camera is off or in standby mode ( 19).
Restore default settings	Restore all network menu settings to their default values.	

* See “Operating the Text Input Keyboard” (144) for information on how to enter alphanumeric characters.



✓ Notes About the Internal Memory

- Images saved in the camera's internal memory cannot be uploaded to a smart device. To upload images in the internal memory, use the playback menu **Copy** to copy the images to the memory card in the camera.
- You cannot perform remote photography from a smart device if a memory card is not inserted in the camera.

Operating the Text Input Keyboard

Character Input for SSID, Password, Image comment, and Copyright information

- Use the multi selector ▲▼◀▶ to select alphanumeric characters. Press the **OK** button to enter the selected character in the text field and move the cursor to the next space.
- To move the cursor in the text field, select ← or → on the keyboard, and press the **OK** button.
- To delete one character, press the **Delete** button.
- To apply the setting, select ↵ on the keyboard and press the **OK** button.

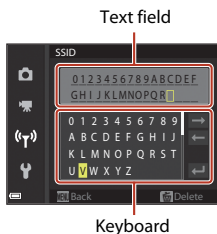

Character Input for Channel, Subnet mask, and DHCP server IP address

- Use the multi selector ▲▼ to set the numbers. To move to the next digit, press ▶ or the **OK** button. To return to the previous digit, press ◀.
- To apply the setting, select the last digit and press the **OK** button.

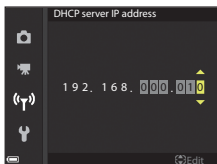

The Setup Menu

Time Zone and Date

Press the **MENU** button → **Y** menu icon → Time zone and date → **OK** button

Set the camera clock.

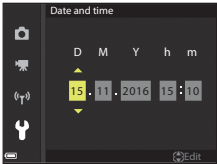
Option	Description
Sync with smart device	Select On to synchronize the date and time setting with a smart device. Enable the clock synchronization function of the SnapBridge app.
Date and time	Set the date and time if Sync with smart device is set to Off . <ul style="list-style-type: none">• Select a field: Press the multi selector ◀▶.• Edit the date and time: Press ▲▼. Date and time can also be changed by rotating the multi selector or command dial.• Apply the setting: Select the minute field setting and press the OK button or ▶. 
Date format	Select Year/Month/Day , Month/Day/Year , or Day/Month/Year .
Time zone	Set the date and time if Sync with smart device is set to Off . Set time zone and daylight saving time. <ul style="list-style-type: none">• When Travel destination (🏠) is set after having set the home time zone (🏠), the time difference between the travel destination and the home time zone is automatically calculated, and the date and time are saved for the selected region.

Setting the Time Zone

- 1 Use the multi selector ▲▼ to select **Time zone** and press the **OK** button.

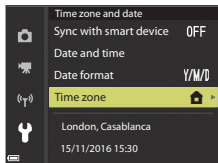

2 Select  **Home time zone** or  **Travel destination** and press the  button.



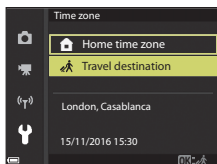

- The date and time displayed on the screen changes depending on whether the home time zone or travel destination is selected.

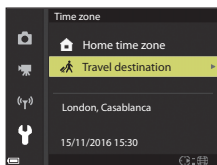

3 Press .



4 Use   to select the time zone.

- Press  to enable daylight saving time function, and  is displayed. Press  to disable the daylight saving time function.
- Press the  button to apply the time zone.
- If the correct time is not displayed for the home or travel destination time zone setting, set the appropriate time in **Date and time**.

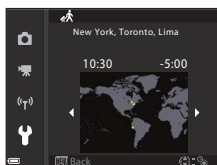





Monitor Settings



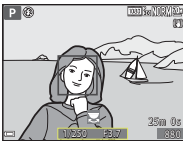

Press the MENU button →  menu icon → Monitor settings →  button

Option	Description
Photo info	Set whether or not to display information in the monitor.
Help display	The descriptions of functions are displayed while changing the shooting mode or while the setting screen is displayed. <ul style="list-style-type: none"> • Default setting: On
Image review	Set whether or not to display the captured image is displayed immediately after shooting. <ul style="list-style-type: none"> • Default setting: On
Brightness	Adjust the brightness. <ul style="list-style-type: none"> • Default setting: 3

Photo info

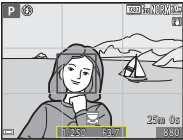
	Shooting mode	Playback mode
Show info		
Auto info (default setting)	The same information as shown in Show info is displayed, and it is hidden as shown in Hide info if no operations are performed for a few seconds. The information is displayed again when an operation is performed.	
Hide info		

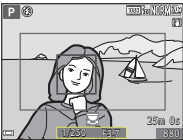

	Shooting mode	Playback mode
Framing grid+auto info	 <p>In addition to the information shown in Auto info, a framing grid is displayed to help frame pictures. The framing grid is not displayed while recording movies.</p>	 <p>Same as Auto info.</p>
Movie frame+auto info	 <p>In addition to the information shown in Auto info, a frame is displayed before movie recording begins that represents the area that will be captured when recording movies. The movie frame is not displayed while recording movies.</p>	 <p>Same as Auto info.</p>



Date Stamp

Press the **MENU** button → **Y** menu icon → Date stamp → **OK** button

The shooting date and time can be stamped on images when shooting.



Option	Description
DATE Date	Date is stamped on images.
DATE Date and time	Date and time are stamped on images.
Off (default setting)	Date and time are not stamped on images.

✓ Notes About Date Stamp



- Stamped date and time form a permanent part of image data and cannot be deleted. The date and time cannot be stamped on images after they have been captured.
- The date and time cannot be stamped in the following situations:
 - When the scene mode is set to **Sports**, **Night portrait** (when set to **Hand-held**), **Night landscape** (when set to **Hand-held**), **Backlighting** (when **HDR** is **On**), **Easy panorama**, **Pet portrait** (when set to **Continuous**), or **Multiple exp. Lighten**
 - When using creative mode
 - When **Continuous** (📖123) is set
 - When recording movies
 - When saving still images during movie recording
 - When extracting still images from a movie during movie playback
- The stamped date and time may be difficult to read when using a small image size.

📎 Printing a Shooting Date on Images Without a Date Stamp



You can transfer images to a computer and use the ViewNX-i software (📖108) to imprint the shooting date and time on the images when they are printed.



Photo VR

Press the **MENU** button →  menu icon → Photo VR →  button

Select the vibration reduction setting used when shooting still images.
Select **Off** when using a tripod to stabilize the camera during shooting.



Option	Description
 * On (hybrid)	Performs optical compensation for camera shake using the lens shift method. Under the following conditions, also performs electronic VR using image processing. <ul style="list-style-type: none">• Flash: Does not fire• Shutter speed: Slower than 1/30 second at the maximum wide-angle position and 1/250 second at the maximum telephoto position• Self-timer: OFF• Continuous setting: Single• ISO sensitivity: ISO 200 or lower The image recording time may be longer than usual.
 On (default setting)	Compensates for camera shake using the lens shift method.
Off	Compensation is not performed.

Notes About Photo VR

- After turning on the camera or after switching from playback mode to shooting mode, wait until the shooting screen is ready before taking pictures.
- Images on the screen may be displayed blurry immediately after shooting.
- Vibration reduction may be unable to completely eliminate the effects of camera shake in some situations.
- When the shutter speed is extremely slow, images cannot be compensated using image processing even when **On (hybrid)** is set.







AF Assist

Press the MENU button →  menu icon → AF assist →  button

Option	Description
AUTO Auto (default setting)	The AF-assist illuminator automatically lights up when you press the shutter-release button under dim lighting. The illuminator has a range of about 5.0 m (16 ft) at the maximum wide-angle position and about 4.5 m (14 ft) at the maximum telephoto position. <ul style="list-style-type: none">Note that for some shooting modes or focus areas, the AF-assist illuminator may not light.
Off	The AF-assist illuminator does not light.

Digital Zoom

Press the MENU button →  menu icon → Digital zoom →  button

Option	Description
On (default setting)	Digital zoom is enabled.
 Crop	The zoom ratio is limited within a range in which the image quality does not deteriorate ( 65). <ul style="list-style-type: none">Digital zoom is not available when the image size is 20M 5184×3888, 15.9M 5184×2920, 11.1M 3888×3888.This setting functions in the same way as the On setting during movie recording.
Off	Digital zoom is disabled.

Notes About Digital Zoom

- Digital zoom cannot be used in the following shooting modes.
 - Portrait, Night portrait, Night landscape, Backlighting** (when **HDR** is set), **Easy panorama, Pet portrait, Smart portrait** scene mode
 - Creative mode
- Digital zoom cannot be used in other shooting modes when using certain settings (74).





Sound Settings

Press the MENU button →  menu icon → Sound settings →  button

Option	Description
Button sound	When On (default setting) is selected, the camera produces one beep when operations are performed, two beeps when focus is acquired on the subject, and three beeps when an error occurs. The welcome screen sound is also produced. <ul style="list-style-type: none">• Sounds are disabled when using Pet portrait scene mode.
Shutter sound	When On (default setting) is selected, the shutter sound is produced when the shutter is released. <ul style="list-style-type: none">• The shutter sound is not produced when recording movies, or when using Easy panorama, or Pet portrait scene mode.

Auto Off

Press the MENU button →  menu icon → Auto off →  button

Set the amount of time that elapses before the camera enters standby mode (19). You can select **30 s**, **1 min** (default setting), **5 min**, or **30 min**.



Setting the Auto Off Function

The time that passes before the camera enters standby mode is fixed in the following situations:

- When shooting with **Pet portrait auto release**: 5 minutes (when auto off is set to **30 s** or **1 min**)
- When shooting with **Smile timer**: 5 minutes (when auto off is set to **30 s** or **1 min**)
- When a menu is displayed: 3 minutes (when auto off is set to **30 s** or **1 min**)
- When an HDMI cable is connected: 30 minutes
- When waiting for connecting with **Connect to smart device**: 30 minutes



Format Card/Format Memory

Press the **MENU** button →  menu icon → Format card/Format memory →  button

Use this option to format a memory card or the internal memory.

Formatting the memory cards or internal memory permanently deletes all data. Data that has been deleted cannot be recovered. Make sure to save important images to a computer before formatting.

- You may not be able to select this setting while a wireless connection is established.

Formatting a Memory Card

- Insert a memory card into the camera.
- Select **Format card** in the setup menu and then press the  button.



Formatting the Internal Memory

- Remove the memory card from the camera.
- Select **Format memory** in the setup menu and then press the  button.

To start formatting, select **Format** on the screen that is displayed and press the  button.

- Do not turn the camera off or open the battery-chamber/memory card slot cover during formatting.

Language

Press the **MENU** button →  menu icon → Language →  button

Select a language for display of camera menus and messages.



Image Comment

Press the **MENU** button →  menu icon → Image comment →  button

Attach a comment that was previously registered to images that will be captured. You can imprint the attached comment to images that will be sent to a smart device using the SnapBridge app. You must configure the SnapBridge app in advance. See SnapBridge app online help for more information.

You can also check the attached comment using ViewNX-i metadata.





Option	Description
Attach comment	<p>A comment registered with Input comment is attached to images.</p> <ul style="list-style-type: none">• Select Attach comment, press , and set the check box to on (). <p>When you press the , the setting is enabled, and the comment will be attached to the images captured afterwards.</p> 
Input comment	<p>You can register a comment of up to 36 alphanumeric characters.</p> <ul style="list-style-type: none">• Select Input comment, press , and the input screen is displayed. <p>See "Operating the Text Input Keyboard" ( 144) for information about the input method.</p>

Image Comments Display

Image comments are not displayed even if images are played back on the camera.

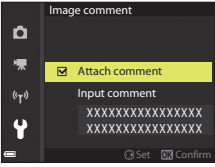

Copyright Information

Press the **MENU** button → **Y** menu icon → **Copyright information** → **OK** button

Attach the copyright information that was previously registered to images that will be captured.

You can imprint the attached copyright information to images that will be sent to a smart device using the SnapBridge app. You must configure the SnapBridge app in advance. See SnapBridge app online help for more information.

You can also check the attached copyright information using ViewNX-i metadata.

Option	Description
Attach copyright info	<p>Copyright information registered with Artist and Copyright is attached to images.</p> <ul style="list-style-type: none">Select Attach copyright info, press ▶, and set the check box to on (✓). When you press the OK button, the setting is enabled, and the copyright information will be attached to the images captured afterwards.
Artist	<p>You can register an artist name of up to 36 alphanumeric characters.</p> <ul style="list-style-type: none">Select Artist, press ▶, and the input screen is displayed. See “Operating the Text Input Keyboard” (📖144) for information about the input method.
Copyright	<p>You can register a copyright owner name of up to 54 alphanumeric characters.</p> <ul style="list-style-type: none">Select Copyright, press ▶, and the input screen is displayed. See “Operating the Text Input Keyboard” (📖144) for information about the input method.

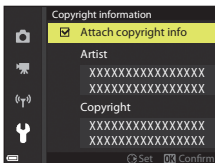

✓ Notes About Copyright Information



- To prevent illegal use of artist names and copyright owner names when lending or transferring ownership of the camera, make sure to disable the **Attach copyright info** setting. Also, make sure that the artist name and copyright owner name are blank.
- Nikon is not responsible for any kind of trouble or damage resulting from the use of **Copyright information**.

📎 Copyright Information Display

- Copyright information is not displayed even if images are played back on the camera.
- When copyright information is entered for both **Artist** and **Copyright**, only the **Copyright** entry is attached to the images in the SnapBridge app.



Location Data



Press the **MENU** button →  menu icon → Location data →  button

Set whether or not to add shooting location information to the images that you take.

Option	Description
Download from device	Select Yes to add location information from the smart device to the images that you take. Enable the location information function of the SnapBridge app.
Position	Display the obtained location information. <ul style="list-style-type: none">• The information is not updated while it is being displayed. To update it, perform Position again.



Charge by Computer

Press the MENU button →  menu icon → Charge by computer →  button

Option	Description
AUTO Auto (default setting)	When the camera is connected to a computer that is running ( 102), the battery inserted into the camera is automatically charged using power supplied by the computer.
Off	The battery inserted into the camera is not charged when the camera is connected to a computer.

Notes About Charging with a Computer

- When connected to a computer, the camera turns on and starts charging. If the camera is turned off, charging stops.
- About 4 hours are required to charge a fully exhausted battery. Charging time increases when images are transferred while the battery is charging.
- The camera turns off automatically if there is no communication with the computer for 30 minutes after the battery has finished charging.

When the Charge Lamp Quickly Flashes Green

Charging cannot be performed, possibly due to one of the reasons described below.

- The ambient temperature is not suited to charging. Charge the battery indoors with an ambient temperature of 5°C to 35°C (41°F to 95°F).
- The USB cable is not connected correctly or the battery is faulty. Make sure that the USB cable is connected correctly or replace the battery if necessary.
- The computer is in sleep mode and is not supplying power. Wake up the computer.
- The battery cannot be charged because the computer cannot supply power to the camera due to the computer's settings or its specifications.



Reset All

Press the **MENU** button → **Y** menu icon → **Reset all** → **OK** button

When **Reset** is selected, the camera's settings are restored to their default values.

- The network menu settings are also restored to their default values.
- Some settings, such as **Time zone and date** or **Language**, are not reset.
- You may not be able to select this setting while a wireless connection is established.

Resetting File Numbering

To reset file numbering to "0001", delete all images saved on the memory card or in the internal memory before selecting **Reset all**.

Conformity Marking

Press the **MENU** button → **Y** menu icon → **Conformity marking** → **OK** button

View some of the conformity markings that the camera complies with.

Firmware Version

Press the **MENU** button → **Y** menu icon → **Firmware version** → **OK** button

View the current camera firmware version.

- You may not be able to select this setting while a wireless connection is established.



Technical Notes

Notices.....	160
Notes About Wireless Communication Functions	162
Caring for the Product	165
The Camera	165
The Battery	166
The Charging AC Adapter.....	167
Memory Cards.....	168
Cleaning and Storage	169
Cleaning	169
Storage	169
Error Messages	170
Troubleshooting.....	173
File Names.....	183
Optional Accessories.....	184
Specifications.....	185
Memory Cards That Can Be Used.....	188
Index	191



Notices

Notices for Customers in the U.S.A.

IMPORTANT SAFETY INSTRUCTIONS - SAVE THESE INSTRUCTIONS.

DANGER - TO REDUCE THE RISK OF FIRE OR ELECTRIC SHOCK, CAREFULLY FOLLOW THESE INSTRUCTIONS

For connection to a supply not in the U.S.A., use an attachment plug adapter of the proper configuration for the power outlet if needed.

The power supply unit is intended to be correctly orientated in a vertical or floor mount position.

Federal Communications Commission (FCC) Radio Frequency Interference Statement

This equipment has been tested and found to comply with the limits for a Class B digital device, pursuant to Part 15 of the FCC rules. These limits are designed to provide reasonable protection against harmful

interference in a residential installation. This equipment generates, uses, and can radiate radio frequency energy and, if not installed and used in accordance with the instructions, may cause harmful interference to radio communications. However, there is no guarantee that interference will not occur in a particular installation. If this equipment does cause harmful interference to radio or television reception, which can be determined by turning the equipment off and on, the user is encouraged to try to correct the interference by one or more of the following measures:

- Reorient or relocate the receiving antenna.
- Increase the separation between the equipment and receiver.
- Connect the equipment into an outlet on a circuit different from that to which the receiver is connected.
- Consult the dealer or an experienced radio/television technician for help.



CAUTIONS

Modifications

The FCC requires the user to be notified that any changes or modifications made to this device that are not expressly approved by Nikon Corporation may void the user's authority to operate the equipment.

Interface Cables

Use the interface cables sold or provided by Nikon for your equipment. Using other interface cables may exceed the limits of Class B Part 15 of the FCC rules.



Notice for Customers in the State of California

WARNING

Handling the cord on this product will expose you to lead, a chemical known to the State of California to cause birth defects or other reproductive harm.

Wash hands after handling.

Nikon Inc.,

1300 Walt Whitman Road, Melville, New York 11747-3064, U.S.A.

Tel: 631-547-4200

Notice for Customers in Canada

CAN ICES-3 B / NMB-3 B

Notices for Customers in Europe

CAUTIONS

RISK OF EXPLOSION IF BATTERY IS REPLACED BY AN INCORRECT TYPE.

DISPOSE OF USED BATTERIES ACCORDING TO THE INSTRUCTIONS.

This symbol indicates that electrical and electronic equipment is to be collected separately.

The following apply only to users in European countries:

- This product is designated for separate collection at an appropriate collection point. Do not dispose of as household waste.
- Separate collection and recycling helps conserve natural resources and prevent negative consequences for human health and the environment that might result from incorrect disposal.
- For more information, contact the retailer or the local authorities in charge of waste management.



This symbol on the battery indicates that the battery is to be collected separately.

The following apply only to users in European countries:

- All batteries, whether marked with this symbol or not, are designated for separate collection at an appropriate collection point. Do not dispose of as household waste.
- For more information, contact the retailer or the local authorities in charge of waste management.



Notes About Wireless Communication Functions

Restrictions on Wireless Devices

The wireless transceiver included in this product conforms to wireless regulations in the country of sale and is not for use in other countries (products purchased in the EU or EFTA can be used anywhere within the EU and EFTA). Nikon does not accept liability for use in other countries. Users who are unsure as to the original country of sale should consult with their local Nikon service center or Nikon-authorized service representative. This restriction applies to wireless operation only and not to any other use of the product.

Security

Although one of the benefits of this product is that it allows others to freely connect for the wireless exchange of data anywhere within its range, the following may occur if security is not enabled:

- Data theft: Malicious third-parties may intercept wireless transmissions to steal user IDs, passwords, and other personal information.
- Unauthorized access: Unauthorized users may gain access to the network and alter data or perform other malicious actions. Note that due to the design of wireless networks, specialized attacks may allow unauthorized access even when security is enabled. Nikon is not responsible for data or information leaks that may occur during data transfer.
- Do not access networks that you are not permitted to use, even if they are displayed on your smartphone or tablet. Doing so may be regarded as unauthorized access. Only access networks that you are permitted to use.

Personal Information Management and Disclaimer

- User information registered and configured on the product, including wireless LAN connection settings and other personal information, is susceptible to alteration and loss resulting from operational error, static electricity, accident, malfunction, repair or other handling. Always keep separate copies of important information. Nikon is not responsible for any direct or indirect damages or lost profits resulting from alteration or loss of content that is not attributable to Nikon.
- Before discarding this product or transferring it to another owner, perform **Reset all** in the setup menu (📖117) to delete all user information registered and configured with the product, including wireless LAN connection settings and other personal information.
- Nikon is not responsible for any damages resulting from unauthorized use of this product by third parties in the event that the product is stolen or lost.



Precautions when Exporting or Carrying This Product Abroad

This product is controlled by the United States Export Administration Regulations (EAR). The permission of the United States government is not required for export to countries other than the following, which as of this writing are subject to embargo or special controls: Cuba, Iran, North Korea, Sudan, and Syria (list subject to change).

Notice for Customers in the U.S.A. and Canada

Federal Communications Commission (FCC) and Industry of Canada (IC)

Declaration of Conformity

This device complies with Part 15 of FCC Rules and Industry Canada licence-exempt RSS standard(s). Operation is subject to the following two conditions: (1) this device may not cause interference, and (2) this device must accept any interference, including interference that may cause undesired operation of this device.

FCC/IC RF Exposure Statement

This transmitter must not be co-located or operated in conjunction with any other antenna or transmitter.

The available scientific evidence does not show that any health problems are associated with using low power wireless devices. There is no proof, however, that these low power wireless devices are absolutely safe. Low power wireless devices emit low levels of radio frequency energy (RF) in the microwave range while being used. Whereas high levels of RF can produce health effects (by heating tissue), exposure of low-level RF that does not produce heating effects causes no known adverse health effects. Many studies of low-level RF exposures have not found any biological effects. Some studies have suggested that some biological effects might occur, but such findings have not been confirmed by additional research.

COOLPIX A900, which is equipped with a TYPE1FJ (FCC ID:VPYLB1FJ / IC ID:772C-LB1FJ) Wireless LAN Module, has been tested and found to comply with FCC/IC radiation exposure limits set forth for an uncontrolled environment and meets the FCC radio frequency (RF) Exposure Guidelines in Supplement C to OET65 and RSS-102 of the IC radio frequency (RF) Exposure rules. Please refer to the SAR test report that was uploaded to FCC website.



Notice for Customers in Europe

Declaration of Conformity (Europe)

Hereby, Nikon Corporation declares that the radio equipment type COOLPIX A900 is in compliance with Directive 2014/53/EU.

The full text of the EU declaration of conformity is available at the following internet address: http://imaging.nikon.com/support/pdf/DoC_A900.pdf.

- Maximum output power: 11.3 dBm (EIRP)
- Operating frequency:
 - Wi-Fi: 2412–2462 MHz (channels 1–11)
 - Bluetooth: 2402–2480 MHz
 - Bluetooth Low Energy: 2402–2480 MHz
 - NFC: 13.56 MHz

Notice for Customers in Singapore

This device complies with radio-frequency regulations.

**Complies with
IMDA Standards
DA103423**



Caring for the Product

Observe the precautions described below in addition to the warnings in "For Your Safety" (📖vi-viii) when using or storing the device.

The Camera

Do Not Apply Strong Impact to the Camera

The product may malfunction if subjected to strong shock or vibration. In addition, do not touch or apply force to the lens or lens cover.

Keep Dry

The device will be damaged if immersed in water or subjected to high humidity.

Avoid Sudden Changes in Temperature

Sudden changes in temperature, such as when entering or leaving a heated building on a cold day, can cause condensation to form inside the device. To prevent condensation, place the device in a carrying case or a plastic bag before exposing it to sudden changes in temperature.

Keep Away from Strong Magnetic Fields

Do not use or store this device in the vicinity of equipment that generates strong electromagnetic radiation or magnetic fields. Doing so could result in loss of data or camera malfunction.

Do Not Point the Lens at Strong Light Sources for Extended Periods

Avoid pointing the lens at the sun or other strong light sources for extended periods when using or storing the camera. Intense light may cause the image sensor to deteriorate or produce a white blur effect in photographs.

Turn the Product Off Before Removing or Disconnecting the Power Source or Memory Card

Do not remove the battery while the product is on, or while images are being saved or deleted. Forcibly cutting power in these circumstances could result in loss of data or in damage to the memory card or internal circuitry.



Notes About the Monitor

- Monitors (including electronic viewfinders) are constructed with extremely high precision; at least 99.99% of pixels are effective, with no more than 0.01% being missing or defective. Hence while these displays may contain pixels that are always lit (white, red, blue, or green) or always off (black), this is not a malfunction and has no effect on images recorded with the device.
- Images in the monitor may be difficult to see under bright lighting.
- Do not apply pressure to the monitor, as this could cause damage or malfunction. Should the monitor break, care should be taken to avoid injury caused by broken glass and to prevent the liquid crystal from the display touching the skin or entering the eyes or mouth.

The Battery

Precautions for Use

- Note that the battery may become hot after use.
- Do not use the battery at ambient temperatures below 0°C (32°F) or above 40°C (104°F) as this could cause damage or malfunction.
- If you notice any abnormalities such as excessive heat, smoke, or an unusual smell coming from the battery, immediately discontinue use and consult your retailer or Nikon-authorized service representative.
- After removing the battery from the camera or optional battery charger, put the battery in a plastic bag, etc. in order to insulate it.

Charging the Battery

Check the battery level before using the camera and replace or charge the battery if necessary.

- Charge the battery indoors with an ambient temperature of 5°C to 35°C (41°F to 95°F) before use.
- A high battery temperature may prevent the battery from charging properly or completely, and may reduce battery performance. Note that the battery may become hot after use; wait for the battery to cool before charging.
When charging the battery inserted into this camera using the Charging AC Adapter or a computer, the battery is not charged at battery temperatures below 0°C (32°F) or above 50°C (122°F).
- Do not continue charging once the battery is fully charged as this will result in reduced battery performance.
- The battery temperature may increase during charging. However, this is not a malfunction.

Carrying Spare Batteries

Whenever possible, carry fully charged spare batteries when taking pictures on important occasions.

Using the Battery When Cold

On cold days, the capacity of batteries tends to decrease. If an exhausted battery is used at a low temperature, the camera may not turn on. Keep spare batteries in a warm place and exchange as necessary. Once warmed, a cold battery may recover some of its charge.



Battery Terminals

Dirt on the battery terminals may prevent the camera from functioning. Should the battery terminals become dirty, wipe them off with a clean, dry cloth before use.

Charging an Exhausted Battery

Turning the camera on or off while an exhausted battery is inserted in the camera may result in reduced battery life. Charge the exhausted battery before use.

Storing the Battery

- Always remove the battery from the camera or optional battery charger when it is not being used. Minute amounts of current are drawn from the battery while it is in the camera, even when not in use. This may result in excessive battery drain and complete loss of function.
- Recharge the battery at least once every six months and completely exhaust it before returning it to storage.
- Put the battery in a plastic bag, etc. in order to insulate it and store it in a cool place. The battery should be stored in a dry location with an ambient temperature of 15°C to 25°C (59°F to 77°F). Do not store the battery in hot or extremely cold locations.

Battery Life

A marked drop in the time a fully charged battery retains its charge, when used at room temperature, indicates that the battery needs to be replaced. Purchase a new battery.

Recycling Used Batteries

Replace the battery when it no longer holds a charge. Used batteries are a valuable resource. Please recycle used batteries in accordance with local regulations.

The Charging AC Adapter

- The EH-73P/EH-73PCH Charging AC Adapter is for use only with compatible devices. Do not use with another make or model of device.
- Do not use any USB cable other than the UC-E21. Using a USB cable other than the UC-E21 could result in overheating, fire or electric shock.
- Do not, under any circumstances, use another make or model of AC adapter other than the EH-73P/EH-73PCH Charging AC Adapter, and do not use a commercially available USB-AC adapter or a battery charger for a mobile phone. Failure to observe this precaution could result in overheating or in damage to the camera.
- The EH-73P/EH-73PCH is compatible with AC 100–240 V, 50/60 Hz electrical outlets. When using in other countries, use a plug adapter (commercially available) as necessary. For more information about plug adapters, consult your travel agency.



Memory Cards

Precautions for Use

- Use only Secure Digital memory cards (📖188).
- Be sure to follow the precautions described in the documentation included with the memory card.
- Do not put labels or stickers on memory cards.

Formatting

- Do not format the memory card using a computer.
- The first time you insert a memory card that has been used in another device into this camera, be sure to format it with this camera. We recommend formatting new memory cards with this camera before using them with this camera.
- **Note that formatting a memory card permanently deletes all images and other data on the memory card.** Be sure to make copies of any images you wish to keep before formatting the memory card.
- If the message **Card is not formatted. Format card?** is displayed when the camera is turned on, the memory card must be formatted. If there is data that you do not want to delete, select **No**. Copy the necessary data to a computer, etc. If you want to format the memory card, select **Yes**. The confirmation dialog will be displayed. To start formatting, press the  button.
- Do not perform the following during formatting, while data is being written to or deleted from the memory card, or during data transfer to a computer. Failure to observe this precaution could result in the loss of data or in damage to the camera or memory card:
 - Open the battery-chamber/memory card slot cover to remove/insert the battery or memory card.
 - Turn off the camera.
 - Disconnect the AC adapter.



Cleaning and Storage

Cleaning

Do not use alcohol, thinner, or other volatile chemicals.

Lens	Avoid touching glass parts with your fingers. Remove dust or lint with a blower (typically a small device with a rubber bulb attached to one end that is pumped to produce a stream of air out the other end). To remove fingerprints or other stains that cannot be removed with a blower, wipe the lens with a soft cloth, using a spiral motion that starts at the center of the lens and working toward the edges. If this fails, clean the lens using a cloth lightly dampened with commercial lens cleaner.
Monitor	Remove dust or lint with a blower. To remove fingerprints and other stains, clean the monitor with a soft, dry cloth, being careful not to apply pressure.
Body	Use a blower to remove dust, dirt, or sand, then wipe gently with a soft, dry cloth. After using the camera at the beach or other sandy or dusty environment, wipe off any sand, dust, or salt with a dry cloth lightly dampened with fresh water and dry thoroughly. Note that foreign matter inside the camera could cause damage not covered by the warranty.

Storage

Remove the battery if the camera will not be used for an extended period. To prevent mold or mildew, take the camera out of storage at least once a month.

Turn the camera on and release the shutter a few times before putting the camera away again. Do not store the camera in any of the following locations:



- Places that are poorly ventilated or subject to humidity of over 60%
- Exposed to temperatures above 50°C (122°F) or below -10°C (14°F)
- Next to equipment that produces strong electromagnetic fields, such as televisions or radios

For storing the battery, follow the precautions in “The Battery” (📖166) in “Caring for the Product” (📖165).



Error Messages









Refer to the table below if an error message is displayed.

Display	Cause/Solution	
Battery temperature is elevated. The camera will turn off.	The camera turns off automatically. Wait until the camera or battery temperature has cooled before resuming use.	-
The camera will turn off to prevent overheating.		
Memory card is write protected.	The write-protect switch is in the "lock" position. Slide the write-protect switch to the "write" position.	-
This card cannot be used.	An error occurred while accessing the memory card. <ul style="list-style-type: none"> • Use an approved memory card. • Check that the terminals are clean. • Confirm that the memory card is correctly inserted. 	10
This card cannot be read.		
Card is not formatted. Format card?	The memory card has not been formatted for use in the camera. Formatting deletes all data saved on the memory card. If you need to keep copies of any images, make sure to select No and save the copies to a computer or other medium before formatting the memory card. Select Yes and press the  button to format the memory card.	10, 168
Out of memory.	Delete images or insert a new memory card.	10, 21
Image cannot be saved.	An error occurred while saving the image. Insert a new memory card or format the memory card or internal memory.	10, 153
	The camera has run out of file numbers. Insert a new memory card or format the memory card or internal memory.	10, 153
	There is insufficient space to save the copy. Delete images from the destination.	21
Image cannot be modified.	Check that the images can be edited.	81, 179
Cannot record movie.	A time-out error occurred while saving the movie on the memory card. Select a memory card with a faster write speed.	90, 188



Display	Cause/Solution	
Memory contains no images.	<p>There are no images in the internal memory or on the memory card.</p> <ul style="list-style-type: none"> Remove the memory card to play back images in the internal memory. To copy the images saved in the camera's internal memory to the memory card, press the MENU button to select Copy in the playback menu. 	10
		112
File contains no image data.	The file was not created or edited with this camera. The file cannot be viewed on this camera.	-
This file cannot be played back.	View the file using a computer or the device used to create or edit this file.	
All images are hidden.	<ul style="list-style-type: none"> There are no images available for a slide show, etc. There are no images that can be displayed on the image selection screen for deletion. 	-
This image cannot be deleted.	The image is protected. Disable protection.	140
Raise the flash.	<ul style="list-style-type: none"> When the scene mode is Scene auto selector, you can take a picture even if the flash is lowered but the flash will not fire. When the scene mode is Night portrait or Backlighting with HDR set to Off, you must raise the flash to take a picture. 	36
		37, 39
No card present.	When shooting time-lapse movies or the shooting mode is set to short movie show mode, insert a memory card.	-
No access.	<p>The camera could not receive the communication signal from the smart device. Wirelessly connect the camera and smart device again.</p> <ul style="list-style-type: none"> Touch an NFC-compatible smart device to the camera. Select Connect to smart device in the Network menu. 	25
		112
Turn the camera off and then on again.	If the error persists, contact your retailer or Nikon-authorized service representative.	-
Communications error	An error occurred while communicating with the printer. Turn the camera off and reconnect the USB cable.	104
System error	An error occurred in the camera's internal circuitry. Turn the camera off, remove and reinsert the battery, and turn the camera on. If the error persists, contact your retailer or Nikon-authorized service representative.	173



Display	Cause/Solution	
Printer error: check printer status.	After solving the problem, select Resume and press the  button to resume printing.*	–
Printer error: check paper.	Load the specified size of paper, select Resume , and press the  button to resume printing.*	–
Printer error: paper jam.	Remove the jammed paper, select Resume , and press the  button to resume printing.*	–
Printer error: out of paper.	Load the specified size of paper, select Resume , and press the  button to resume printing.*	–
Printer error: check ink.	There is a problem with the printer's ink. Check the ink, select Resume , and press the  button to resume printing.*	–
Printer error: out of ink.	Replace the ink cartridge, select Resume , and press the  button to resume printing.*	–
Printer error: file corrupt.	There is a problem with the image file to be printed. Select Cancel and press the  button to cancel printing.*	–

* See the documentation provided with your printer for further guidance and information.





Troubleshooting

If the camera fails to function as expected, check the list of common problems below before consulting your retailer or Nikon-authorized service representative.

Power, Display, Settings Issues

Problem	Cause/Solution	
The camera is on but does not respond.	<ul style="list-style-type: none">• Wait for recording to end.• If the problem persists, turn the camera off. If the camera does not turn off, remove and reinsert the battery or batteries or, if you are using an AC adapter, disconnect and reconnect the AC adapter. Note that although any data currently being recorded will be lost, data that have already been recorded will not be affected by removing or disconnecting the power source.	–
The camera cannot be turned on.	<ul style="list-style-type: none">• The battery is exhausted.• The power switch is enabled a few seconds after the battery is inserted. Wait a few seconds before pressing the power switch.	10, 11, 166 –
The camera turns off without warning.	<ul style="list-style-type: none">• The camera automatically turns off to save power (auto off function).• The camera and battery may not work properly at low temperatures.• The inside of the camera has become hot. Leave the camera off until the inside of the camera has cooled, and then try turning it on again.	19 166 –
The monitor is blank.	<ul style="list-style-type: none">• The camera is off.• The battery is exhausted.• The camera automatically turns off to save power (auto off function).• The flash lamp flashes while the flash is charging. Wait until charging is complete.• The camera is connected to a TV or computer.• Time-lapse movie shooting is in progress.• The camera and smart device are connected using Wi-Fi connection and the camera is operated by remote control.	14 17 19 57 – – –





Problem	Cause/Solution	
The camera becomes hot.	The camera may become hot when used for an extended period of time to record movies or send images, or when used in a hot environment; this is not a malfunction.	–
The battery inserted in the camera cannot be charged.	<ul style="list-style-type: none"> • Confirm all connections. • When connected to a computer, the camera may not charge for any of the reasons described below. <ul style="list-style-type: none"> - Off is selected for Charge by computer in the setup menu. - Battery charging stops if the camera is turned off. - Battery charging is not possible if the camera's display language and date and time have not been set, or the date and time were reset after the camera's clock battery was exhausted. Use the Charging AC Adapter to charge the battery. - Battery charging may stop when the computer enters sleep mode. - Depending on the computer specifications, settings, and status, battery charging may not be possible. 	11 112, 117, 157 – 14, 174 – –
The monitor is hard to see.	<ul style="list-style-type: none"> • The surrounding area is too bright. <ul style="list-style-type: none"> - Move to a darker place. • Adjust the screen brightness 	– 112, 117, 147
 flashes on the screen.	<ul style="list-style-type: none"> • If the camera clock has not been set,  flashes on the shooting screen, and images and movies saved before the clock is set are dated "00/00/0000 00:00" and "01/01/2016 00:00" respectively. Set the correct time and date for Time zone and date option in the setup menu. 	4, 112, 117, 145
Date and time of recording are not correct.	<ul style="list-style-type: none"> • The camera clock is not as accurate as ordinary watches or clocks. Periodically compare the time of the camera clock with that of a more accurate timepiece and reset as required. 	
No indicators displayed on the screen.	Hide info is selected for Photo info in Monitor settings in the setup menu.	4, 112, 117, 147
Date stamp not available.	Time zone and date has not been set in the setup menu.	4, 112, 117, 145





Problem	Cause/Solution	
Date not stamped on images even when Date stamp is enabled.	<ul style="list-style-type: none"> • The current shooting mode does not support Date stamp. • A function that restricts the date stamp is enabled. • The date cannot be stamped on movies. 	4, 112, 117, 149 73 –
Screen for setting time zone and date is displayed when the camera is turned on. The camera settings reset.	<p>The clock battery is exhausted; all settings were restored to their default values. Configure the camera settings again.</p> <ul style="list-style-type: none"> • The internal clock battery is used to power the camera clock and to retain certain settings. Charging time of the clock battery takes about 10 hours when you insert the batteries into the camera or connect the AC adapter (available separately) to the camera, and the clock battery operates for several days even after the camera battery is removed. 	–
The camera makes sound.	Depending on the Autofocus mode setting or the shooting mode, the camera may produce an audible focusing sound.	33, 112, 115, 129, 135
Unable to select a menu.	<ul style="list-style-type: none"> • Some functions cannot be used with other menu options. • Some menus are not available when Wi-Fi is connected. Turn the camera off and terminate the Wi-Fi connection. 	73 –







Shooting Issues

Problem	Cause/Solution	
Cannot switch to shooting mode.	Disconnect the HDMI cable or USB cable.	102
Cannot take pictures or record movies.	<ul style="list-style-type: none"> When the camera is in playback mode, press the  button, shutter-release button, or  button. When menus are displayed, press the MENU button. When the scene mode is Night portrait or Backlighting with HDR set to Off, raise the flash. The flash is charging while the flash lamp is flashing. The camera and smart device are connected using Wi-Fi connection and the camera is operated by remote control. The battery is exhausted. 	2, 20 113 35, 57 57 30 10, 11, 166
The camera cannot focus.	<ul style="list-style-type: none"> The subject is too close. Try shooting using Scene auto selector or Close-up scene mode, or macro mode. The subject is hard to focus on. Set AF assist in the setup menu to Auto. Turn the camera off and then on again. 	35, 36, 38, 61 69 112, 117, 151 –
Colored stripes appear on the screen when shooting.	Colored stripes may appear when shooting subjects with repeating patterns (such as window blinds); this is not a malfunction. The colored stripes will not appear in captured images or recorded movies. However, when using Continuous H: 120 fps or HS 480/4x , the colored stripes may be seen in the captured images and recorded movies.	–
Images are blurred.	<ul style="list-style-type: none"> Use the flash. Increase the ISO sensitivity value. Enable Photo VR when shooting still images. Enable Movie VR when recording movies. Use a tripod to stabilize the camera (using the selftimer at the same time is more effective). 	19, 57 112, 115, 125 112, 115, 117, 136, 150 60



Problem	Cause/Solution	
Bright specks appear in images captured with flash.	Flash is reflecting off particles in the air. Lower the flash, and set the flash mode setting to  (off).	57
Flash does not fire.	<ul style="list-style-type: none"> • A shooting mode that restricts the flash is selected. • A function that restricts the flash is enabled. 	71 73
Digital zoom cannot be used.	<ul style="list-style-type: none"> • Digital zoom is set to Off or Crop in the setup menu. • When movie recording starts with Movie options set to 2160p 60 2160/30p (4K UHD) or 2160p 25 2160/25p (4K UHD), the digital zoom magnification is restricted up to approximately 2x. • Digital zoom cannot be used with certain shooting modes or when using certain settings in other functions. 	112, 117, 151 130, 151 74, 112, 117, 151
Image size not available.	<ul style="list-style-type: none"> • A function that restricts the Image size option is enabled. • When the scene mode is set to Easy panorama, the image size is fixed. 	73 44
No sound when the shutter is released.	Off is selected for Shutter sound in Sound settings in the setup menu. No sound is produced with some shooting modes and settings, even when On is selected.	47, 117, 152
AF-assist illuminator does not light.	Off is selected for the AF assist option in the setup menu. AF-assist illuminator may not light depending on the position of the focus area or the current shooting mode, even when Auto is selected.	112, 117, 151
Images appear smeared.	The lens is dirty. Clean the lens.	169
Colors are unnatural.	White balance or hue is not adjusted properly.	38, 112, 115, 120
Randomly spaced bright pixels ("noise") appear in image.	The subject is dark and the shutter speed is too slow or ISO sensitivity is too high. Noise can be reduced by: <ul style="list-style-type: none"> • Using the flash • Specifying a lower ISO sensitivity setting 	19, 57 112, 115, 125



Problem	Cause/Solution	
Images are too dark	<ul style="list-style-type: none"> The flash window is blocked. The subject is beyond the range of the flash. Adjust exposure compensation. Increase ISO sensitivity. The subject is backlit. Use the flash or the Backlighting scene mode. 	17 186 62, 64 112, 115, 125 19, 39, 57
Images are too bright.	Adjust exposure compensation.	62, 64
Unexpected results when flash set to  (auto with redeste reduction/ red-eye reduction).	Use any shooting mode other than Night portrait , and change the flash mode to any setting other than  (auto with red-eye reduction/red-eye reduction) and try taking the picture again.	37, 71
Skin tones are not softened.	<ul style="list-style-type: none"> Under some shooting conditions, facial skin tones may not be softened. For images containing four or more faces, try using the Skin softening effect in Glamour retouch in the playback menu. 	42 83, 112, 116
Saving images takes time.	<p>It may take more time to save images in the following situations:</p> <ul style="list-style-type: none"> When the noise reduction function is in operation, such as when shooting in a dark environment When the flash mode is set to  (auto with red-eye reduction/red-eye reduction) When capturing images in the following scene modes <ul style="list-style-type: none"> Hand-held in Night portrait Hand-held in Night landscape HDR set to On in Backlighting Easy panorama When the skin softening function is applied while shooting When using continuous shooting mode 	– 58 37 37 39 43 42 123





Problem	Cause/Solution	
A ring-shaped belt or rainbow-colored stripe appears on the screen or images.	When shooting with backlighting or when a very strong light source (such as sunlight) is in the frame, a ring-shaped belt or rainbow-colored stripe (ghosting) may occur. Change the position of the light source, or frame the picture so that the light source does not enter the frame, and try again.	–

Playback Issues



Problem	Cause/Solution	
File cannot be played back.	<ul style="list-style-type: none"> This camera may not be able to play back images saved with another make or model of digital camera. This camera cannot play back movies recorded with another make or model of digital camera. This camera may not be able to play back data edited on a computer. 	–
Cannot zoom in on image.	<ul style="list-style-type: none"> Playback zoom cannot be used with movies. This camera may not be able to zoom in on images captured with another make or model of digital camera. When zooming in on a small-sized image, the magnification rate shown on the screen may differ from the actual magnification rate of the image. 	–
Cannot edit image.	<ul style="list-style-type: none"> Some images cannot be edited. Images that have already been edited may not be edited again. There is not enough free space on the memory card or in the internal memory. This camera is unable to edit images captured with other cameras. Editing functions used for images are not available for movies. 	44, 81 – – –
Cannot rotate image.	This camera cannot rotate images captured with another make or model of digital camera.	–



External Device Issues

Problem	Cause/Solution	
Cannot establish a wireless connection with a smart device.*	<ul style="list-style-type: none"> • See “Connecting to a Smart Device (SnapBridge)” when establishing a wireless connection for the first time. 	23
	<ul style="list-style-type: none"> • Also see “If the Connection Is Unsuccessful”. 	28
	<ul style="list-style-type: none"> • If a wireless connection is established, perform the following operations. 	
	<ul style="list-style-type: none"> - Turn the camera off and then on again. 	31
	<ul style="list-style-type: none"> - Restart the SnapBridge app. 	-
	<ul style="list-style-type: none"> - Cancel the connection and then establish a connection again. 	31
	<ul style="list-style-type: none"> • Check the Network menu settings in the camera. 	143
	<ul style="list-style-type: none"> - Set Airplane mode to Off. 	
	<ul style="list-style-type: none"> - Set Bluetooth → Connection to Enable. 	
	<ul style="list-style-type: none"> • If the camera is registered with two or more smart devices, select the smart device that you want to connect in Network menu → Bluetooth → Paired devices in the camera. If two or more cameras are registered in the SnapBridge app, switch the connection on the app. 	143
<ul style="list-style-type: none"> • Use a sufficiently charged battery. 	-	
<ul style="list-style-type: none"> • Insert a memory card with sufficient free space into the camera. 	10	
<ul style="list-style-type: none"> • Disconnect the HDMI cable or USB cable. 	102	
<ul style="list-style-type: none"> • Enable Bluetooth, Wi-Fi, and the location data functions on the smart device. 	-	
<ul style="list-style-type: none"> • In the  tab of the SnapBridge app → Auto link options → turn on Auto link. If it is off, Download pictures and Remote photography can be used, but images cannot be downloaded automatically. 	-	



Problem	Cause/Solution	
<p>Cannot upload images to a smart device that has a wireless connection established with the SnapBridge app.*</p>	<ul style="list-style-type: none"> • Perform the operations described below when uploading automatically. <ul style="list-style-type: none"> - Set Network menu → Send while shooting → Still images in the camera to Yes. - In the  tab of the SnapBridge app → Auto link options → turn on Auto link. - In the  tab of the SnapBridge app → Auto link options → turn on Auto download. - If Network menu → Bluetooth → Send while off in the camera is set to Off, turn on the camera or change the setting to On. • Insert a memory card into the camera. Images saved in the internal memory cannot be uploaded. • You may not be able to upload images or uploading may be canceled while the camera is being operated. • Depending on the status of the camera, you may not be able to upload images or uploading may be canceled. • See also "If Images Cannot Be Uploaded Successfully". 	<p>143</p> <p>–</p> <p>–</p> <p>143</p> <p>10</p> <p>–</p> <p>31</p> <p>31</p>
<p>Cannot perform remote photography from a smart device that has a wireless connection established with the SnapBridge app.*</p>	<ul style="list-style-type: none"> • Remote photography cannot be performed when a memory card is not inserted into the camera. Insert a memory card. • You may not be able to perform remote photography while the camera is being operated. • Depending on the status of the camera, you may not be able to perform remote photography. 	<p>30</p> <p>–</p> <p>31</p>
<p>Cannot download still images at the original size in the SnapBridge app.*</p>	<p>For Send while shooting and Mark for upload in the camera, the size of images that are downloaded is restricted to 2 megapixels. To download still images at their original size, use Download pictures in the SnapBridge app.</p>	<p>–</p>
<p>Images saved in the camera are not displayed on a connected smart device or computer.</p>	<p>If the number of images saved on a memory card in the camera exceeds 10,000, images captured thereafter may not be displayed in a connected device.</p> <ul style="list-style-type: none"> • Reduce the number of images saved on the memory card. Copy the necessary images to a computer, etc. 	<p>–</p>



Problem	Cause/Solution	
Images are not displayed on TV.	<ul style="list-style-type: none"> • A computer or printer is connected to the camera. • The memory card contains no images. • Remove the memory card to play back images in the internal memory. 	<p>–</p> <p>–</p> <p>10</p>
Nikon Transfer 2 does not start when the camera is connected to a computer.	<ul style="list-style-type: none"> • The camera is off. • The battery is exhausted. • The USB cable is not correctly connected. • The camera is not recognized by the computer. • The computer is not set to start Nikon Transfer 2 automatically. For more information about Nikon Transfer 2, refer to help information contained in ViewNX-i. 	<p>–</p> <p>10, 11, 166</p> <p>102, 108</p> <p>–</p> <p>–</p>
The PictBridge screen is not displayed when the camera is connected to a printer.	<p>With some PictBridge-compatible printers, the PictBridge screen may not be displayed and it may be impossible to print images when Auto is selected for Charge by computer in the setup menu. Set the Charge by computer to Off and reconnect the camera to the printer.</p>	<p>112, 117, 157</p>
Images to be printed are not displayed.	<ul style="list-style-type: none"> • The memory card contains no images. • Remove the memory card to print images in the internal memory. 	<p>–</p> <p>10</p>
Cannot select paper size with the camera.	<p>The camera cannot be used to select the paper size in the following situations, even when printing from a PictBridge-compatible printer. Use the printer to select the paper size.</p> <ul style="list-style-type: none"> • The printer does not support the paper sizes specified by the camera. • The printer automatically selects the paper size. 	<p>–</p>

* See “Connecting to a Smart Device (SnapBridge)” (23) and the SnapBridge online help.



File Names

Images or movies are assigned file names as follows.

File name: **DSCN0001.JPG**

(1) (2) (3)

(1) Identifier	Not shown on the screen of the camera. <ul style="list-style-type: none">• DSCN: Original still images, movies, still images created by the movie editing function• SSCN: Small picture copies• RSCN: Cropped copies• FSCN: Images created by an image editing function other than crop and small picture, movies created by the movie editing function
(2) File number	Assigned in ascending order, starting with "0001" and ending with "9999."
(3) Extension	Indicates file format. <ul style="list-style-type: none">• .JPG: Still images• .MP4: Movies



Optional Accessories

Battery Charger

MH-65 Battery Charger

Charging time is about 2 hours and 30 minutes for a fully exhausted battery.

AC Adapter

EH-62F AC Adapter

(connect as shown)

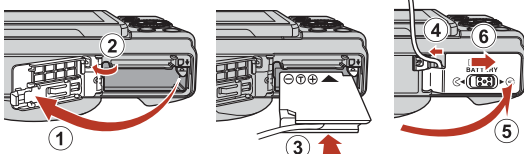

Make sure that the power connector cable is fully inserted in the power connector slot before inserting the AC adapter into the battery chamber. In addition, make sure that the power connector cable is fully inserted in the battery chamber slot before closing the battery-chamber/memory card slot cover. If part of the cable protrudes from the slots, the cover or cable may be damaged when the cover is closed.

Availability may vary with country or region.

See our website or brochures for the latest information.



Specifications

Nikon COOLPIX A900 Digital Camera

Type	Compact digital camera
Number of effective pixels	20.3 million (Image processing may reduce the number of effective pixels.)
Image sensor	1/2.3-in. type CMOS; approx. 21.14 million total pixels
Lens	NIKKOR lens with 35× optical zoom
Focal length	4.3–151 mm (angle of view equivalent to that of 24–840 mm lens in 35mm [135] format)
f/-number	f/3.4–6.9
Construction	13 elements in 11 groups (4 ED lens elements)
Digital zoom magnification	Up to 4× (angle of view equivalent to that of approx. 3360 mm lens in 35mm [135] format)
Vibration reduction	Combination of lens shift and electronic VR
Autofocus (AF)	Contrast-detect AF
Focus range	<ul style="list-style-type: none">• [W]: Approx. 50 cm (1 ft 8 in.)–∞, [T]: Approx. 2.0 m (6 ft 7 in.)–∞• Macro mode: Approx. 1 cm (0.4 in.)–∞ (wide-angle position) (All distances measured from center of front surface of lens)
Focus-area selection	Face priority, manual with 99 focus areas, center, subject tracking, target finding AF
Monitor	7.5 cm (3-in.), approx. 921k-dot (RGBW), wide viewing angle TFT LCD with anti-reflection coating and 6-level brightness adjustment, tilting TFT LCD
Frame coverage (shooting mode)	Approx. 98% horizontal and vertical (compared to actual picture)
Frame coverage (playback mode)	Approx. 100% horizontal and vertical (compared to actual picture)
Storage	
Media	Internal memory (approx. 44 MB) SD/SDHC/SDXC memory card
File system	DCF and Exif 2.3 compliant
File formats	Still images: JPEG Movies: MP4 (Video: H.264/MPEG-4 AVC, Audio: AAC stereo)





Image size (pixels)	<ul style="list-style-type: none"> • 20 M 5184×3888 • 10 M 3648×2736 • 4 M 2272×1704 • 2 M 1600×1200 • VGA 640×480 • 16:9 15 M 5184×2920 • 1:1 3888×3888
ISO sensitivity (Standard output sensitivity)	<ul style="list-style-type: none"> • ISO 80–1600 • ISO 3200 (available when using P, S, A, or M mode)
Exposure	
Metering mode	Matrix, center-weighted, spot (digital zoom 2× or more)
Exposure control	Programmed auto exposure with flexible program, shutter-priority auto, aperture-priority auto, manual, and exposure compensation (–2.0 – +2.0 EV in steps of 1/3 EV)
Shutter	Mechanical and CMOS electronic shutter
Speed	<ul style="list-style-type: none"> • 1/2000–1 s • 1/2000–8 s (when ISO sensitivity is fixed at ISO 80, 100, or 200 in S, A, or M mode) • 1/4000 s (maximum speed during high-speed continuous shooting) • 25 s (Star trails in Multiple exp. Lighten scene mode)
Aperture	Electromagnetic 3-blade iris diaphragm
Range	7 steps of 1/3 EV (W) (A , M mode)
Self-timer	<ul style="list-style-type: none"> • 10 s, 2 s • 5 s (self-portrait timer)
Flash	
Range (approx.) (ISO sensitivity: Auto)	[W]: 0.5–6.0 m (1 ft 8 in.–19 ft) [T]: 1.5–3.0 m (5 ft–9 ft 10 in.)
Flash control	TTL auto flash with monitor preflashes
Interface	
USB connector	Micro-USB connector (Do not use any USB cable other than the included UC-E21 USB Cable.), Hi-Speed USB <ul style="list-style-type: none"> • Supports Direct Print (PictBridge)
HDMI output connector	HDMI micro connector (Type D)



Wi-Fi (Wireless LAN)	
Standards	IEEE 802.11b/g (standard wireless LAN protocol)
Operating frequency	2412–2462 MHz (channels 1-11)
Authentication	Open system, WPA2-PSK
Bluetooth	
Communication protocols	Bluetooth Specification Version 4.1
Supported languages	Arabic, Bengali, Bulgarian, Chinese (Simplified and Traditional), Czech, Danish, Dutch, English, Finnish, French, German, Greek, Hindi, Hungarian, Indonesian, Italian, Japanese, Korean, Marathi, Norwegian, Persian, Polish, Portuguese (European and Brazilian), Romanian, Russian, Serbian, Spanish, Swedish, Tamil, Telugu, Thai, Turkish, Ukrainian, Vietnamese
Power sources	One EN-EL12 Rechargeable Li-ion Battery (included) EH-62F AC Adapter (available separately)
Charging time	Approx. 2 h 20 min (when using EH-73P/EH-73PCH Charging AC Adapter and when no charge remains)
Battery life¹	
Still images	Approx. 270 shots when using EN-EL12
Movie (actual battery life for recording) ²	Approx. 50 min when using EN-EL12
Tripod socket	1/4 (ISO 1222)
Dimensions (W × H × D)	Approx. 113.0 × 66.5 × 39.9 mm (4.5 × 2.7 × 1.6 in.) (excluding projections)
Weight	Approx. 299 g (10.6 oz) (including battery and memory card)
Operating environment	
Temperature	0°C–40°C (32°F–104°F)
Humidity	85% or less (no condensation)

- All measurements are performed in conformity with Camera and Imaging Products Association (CIPA) standards or guidelines.

¹ Battery life does not reflect the use of SnapBridge and may vary with the conditions of use, including temperature, the interval between shots, and the length of time that menus and images are displayed.

² Individual movie files cannot exceed 4 GB in size or 29 minutes in length. When **Movie options** is set to  **1080/30p** or  **1080/25p**, it cannot exceed approximately 26 minutes in length. Recording may end before this limit is reached if camera temperature becomes elevated.



EN-EL12 Rechargeable Li-ion Battery

Type	Rechargeable lithium-ion battery
Rated capacity	DC 3.7 V, 1050 mAh
Operating temperature	0°C–40°C (32°F–104°F)
Dimensions (W × H × D)	Approx. 32 × 43.8 × 7.9 mm (1.3 × 1.7 × 0.3 in.)
Weight	Approx. 22.5 g (0.8 oz)

EH-73P/EH-73PCH Charging AC Adapter

Rated input	AC 100–240 V, 50/60 Hz, MAX 0.14 A
Rated output	DC 5.0 V, 1.0 A
Operating temperature	0°C–40°C (32°F–104°F)
Dimensions (W × H × D)	Approx. 55 × 22 × 54 mm (2.2 × 0.9 × 2.2 in.) (excluding plug adapter) For Brazil: Approx. 55 × 67 × 59 mm For India: Approx. 55 × 63.5 × 59 mm
Weight	Approx. 51 g (1.8 oz) (excluding plug adapter) For Brazil: Approx. 73 g For India: Approx. 76 g



The symbols on this product represent the following:

~ AC, — DC,  Class II equipment (The construction of the product is double-insulated.)

- Nikon will not be held liable for any errors this manual may contain.
- The appearance of this product and its specifications are subject to change without notice.

Memory Cards That Can Be Used

The camera supports SD, SDHC, and SDXC memory cards, including SDHC and SDXC cards compliant with UHS-I.

- Cards rated Speed Class 6 or better are recommended for movie recording (when **Movie options** is set to  **2160/30p** (4K UHD) or  **2160/25p** (4K UHD), cards rated UHS Speed Class 3 or better are recommended); using slower cards may result in recording being interrupted.
- When choosing cards for use in card readers, be sure they are compatible with the device.
- Contact the manufacturer for information on features, operation, and limitations on use.



Trademark Information

- Windows is either a registered trademark or trademark of Microsoft Corporation in the United States and/or other countries.
- The *Bluetooth*® word mark and logos are registered trademarks owned by Bluetooth SIG, Inc. and any use of such marks by Nikon Corporation is under license.
- Apple®, App Store®, the Apple logos, Mac, OS X, macOS, iPhone®, iPad®, iPod touch® and iBooks are trademarks of Apple Inc., registered in the U.S. and other countries.
- Android and Google Play are trademarks or registered trademarks of Google Inc. The Android robot is reproduced or modified from work created and shared by Google and used according to terms described in the Creative Commons 3.0 Attribution License.
- iOS is a trademark or registered trademark of Cisco Systems, Inc., in the United States and/or other countries and is used under license.
- Adobe, the Adobe logo, and Reader are either trademarks or registered trademarks of Adobe Systems Incorporated in the United States and/or other countries.
- SDXC, SDHC, and SD Logos are trademarks of SD-3C, LLC.



- PictBridge is a trademark.
- HDMI, HDMI logo and High-Definition Multimedia Interface are trademarks or registered trademarks of HDMI Licensing, LLC.

HDMI

- Wi-Fi and the Wi-Fi logo are trademarks or registered trademarks of the Wi-Fi Alliance.
- The N-Mark is a trademark or registered trademark of NFC Forum, Inc. in the United States and in other countries.
- All other trade names mentioned in this manual or the other documentation provided with your Nikon product are the trademarks or registered trademarks of their respective holders.



“Made for iPod,” “Made for iPhone,” and “Made for iPad” mean that an electronic accessory has been designed to connect specifically to iPod, iPhone, or iPad, respectively, and has been certified by the developer to meet Apple performance standards. Apple is not responsible for the operation of this device or its compliance with safety and regulatory standards. Please note that the use of this accessory with iPod, iPhone, or iPad may affect wireless performance.

AVC Patent Portfolio License

This product is licensed under the AVC Patent Portfolio License for the personal and non-commercial use of a consumer to (i) encode video in compliance with the AVC standard (“AVC video”) and/or (ii) decode AVC video that was encoded by a consumer engaged in a personal and non-commercial activity and/or was obtained from a video provider licensed to provide AVC video. No license is granted or shall be implied for any other use. Additional information may be obtained from MPEG LA, L.L.C. See <http://www.mpegla.com>.

FreeType License (FreeType2)

Portions of this software are copyright © 2012 The FreeType Project (<http://www.freetype.org>). All rights reserved.

MIT License (HarfBuzz)

Portions of this software are copyright © 2016 The HarfBuzz Project (<http://www.freedesktop.org/wiki/Software/HarfBuzz>). All rights reserved.







Index







Symbols

- Auto mode 33, 34
- Creative mode 33, 50
- SCENE** Scene mode 33, 35
- A** Aperture-priority auto mode
..... 33, 52
- S** Shutter-priority auto mode.... 33, 52
- Short movie show mode 33, 95
- P** Programmed auto mode 33, 52
- M** Manual mode 33, 52
- Playback mode 20, 75
- List by date mode 78
- (Snap-back zoom) button 66
- Playback zoom 20, 76
- W** (Wide-angle) 18, 65
- Thumbnail display 20, 77
- T** (Telephoto) 18, 65
- Apply selection button 3, 14
- Playback button 3, 20
- Delete button 3, 21, 80
- (Movie-record) button
..... 3, 19, 88
- Flash pop-up control 3, 19, 57
- MENU** Menu button 3, 112
- Self-timer 56, 60
- Macro mode 56, 61
- Flash mode 56, 57
- Creative slider 56, 62
- Exposure compensation 56, 64
- N-Mark 25
- A**
- AC adapter 102, 184
- Active D-Lighting 56, 62
- AF area mode 115, 126, 134
- AF assist 117, 151
- Airplane mode 116, 143
- Aperture-priority auto mode 52
- Application 24
- Artist 155
- Auto flash 58
- Auto off 19, 117, 152
- Auto with red-eye reduction 58, 59
- Autofocus 69
- Autofocus mode 115, 129, 135
- B**
- Backlighting 35, 39
- Battery 10, 11, 166, 187
- Battery charger 184
- Battery level indicator 17
- Beach 35
- Blink proof 48
- Bluetooth 117, 143
- Brightness 117, 147
- Button sound 152
- C**
- Calendar display 77
- Charge by computer 117, 157
- Charge lamp 3, 11
- Charging AC Adapter 11, 167, 188
- Charging time 11, 157, 187
- Close-up 35, 38
- Command dial 2, 52
- Computer 102, 108
- Conformity marking 117, 158
- Connect to smart device
..... 25, 116, 143
- Connector cover 2, 11, 102
- Continuous 115, 123
- Copy 116, 141
- Copyright information 117, 155
- Creative mode 33, 50









Creative slider	56, 62	Focus area	18, 40, 67, 126
Crop	76, 86	Focus indicator	4, 18
D		Focus lock	70
Date and time	14, 117, 145	Food 	35, 38
Date stamp	117, 149	Format	10, 117, 153
Daylight saving time	15, 146	Format card	117, 153
Delete	21, 80	Format internal memory	117, 153
Digital zoom	65, 117, 151	Format memory	117, 153
Direct Print	102, 104	Format memory cards	
D-Lighting	82, 116	10, 117, 153, 168
Download from device	156	Formatting	153
Dusk/dawn 	35	Frame rate	116, 137
Dynamic Fine Zoom	65	Framing grid	148
E		Full-frame playback	6, 20, 76, 77
Easy panorama 	35, 43	Full-time AF	129, 135
Editing movies	99	Functions that cannot be used	
Editing still images	81	simultaneously	73
Error messages	170	G	
Exposure compensation	56, 64	Glamour retouch	83, 116
Exposure setting	53	H	
Extension	183	HDMI micro connector	102, 103
Extracting movies	99	HDR	39
Extracting still images	98, 100	Help display	33, 147
Eyelet for camera strap	9	High-speed continuous	123
E		Histogram	62, 64
Face detection	42, 68	HS movie	131, 133
Face priority	115, 126, 134	Hue	38, 56, 62, 120
Fast motion movies	131, 133	I	
File name	183	Identifier	183
Fill flash	58	Image comment	117, 154
Fireworks show 	35, 38	Image quality	115, 118
Firmware version	117, 158	Image selection screen	114
Flash	19, 57	Image size	115, 119
Flash mode	56, 57	Internal memory	10
F-number	52	Internal memory indicator	4, 6, 17
Focal length	185	ISO sensitivity	115, 125
Focus	18, 67, 129, 135		



L	
Landscape 	35
Language	117, 153
Lens.....	2, 169, 185
Li-ion rechargeable battery	10, 11, 166, 188
List by date mode	78
Location data	117, 156
M	
M exposure preview.....	115, 129
Macro mode.....	56, 61
Manual mode	52
Mark for upload	116, 138
Memory capacity.....	17, 88
Memory card.....	10, 168, 188
Metering	115, 122
Micro-USB connector	11, 104, 108
Mode dial	17, 33
Monitor.....	4, 13, 169
Monitor settings.....	117, 147
Movie frame.....	148
Movie menu	115, 130
Movie options	88, 115, 130
Movie playback.....	20, 88, 98
Movie recording.....	19, 88
Movie recording time remaining	88, 89
Movie VR.....	115, 136
Multi selector	3, 56
Multiple exposure lighten 	35, 41
N	
Network menu.....	112, 143
Night landscape 	35, 37
Night portrait 	35, 37
Nightscape + light trails.....	41
Nightscape + star trails	41
Nikon Transfer 2	110
N-Mark (NFC antenna)	2, 25
	Notes about wireless communication functions.....
	162
	Number of exposures remaining
	17, 118
O	
Optical zoom.....	18, 65
Optional accessories.....	184
P	
Panorama	35, 43
Paper size.....	105, 106
Party/indoor 	35, 37
Pet portrait 	35, 40
Photo VR.....	117, 150
PictBridge	102, 104
Playback	20, 75, 88
Playback menu.....	112, 116
Playback mode.....	20, 75
Playback zoom	20, 76
Portrait 	35
Power	14
Power switch.....	2, 3, 14
Power-on lamp	2, 3, 19
Preset manual.....	121
Pre-shooting cache	123, 124
Pressing halfway	18, 67
Print.....	104, 105, 106
Printer	102, 104
Programmed auto mode	52
Protect.....	116, 140
Q	
Quick effects.....	20, 81
Quick retouch.....	82, 116
R	
Rechargeable battery	10, 11, 166, 188
Red-eye correction	83, 116
Red-eye reduction	58, 59



Reset all.....	117, 158	Sports 	35, 36
Restore default settings	117, 143	Standard flash.....	58
Rotary multi selector.....	3, 56	Star trails.....	41, 92
Rotate image.....	116, 140	Subject tracking	127, 128
S		Sunset 	35
Scene auto selector 	33, 36	Superlapse movie 	35, 94
Scene mode	33, 35	Sync with smart device.....	145
SD memory card.....	10, 168, 188	T	
Self-collage.....	47	Target finding AF.....	69, 127
Self-portrait timer.....	56, 60	Text input	144
Self-timer	56, 60	Thumbnail playback.....	20, 77
Self-timer lamp	60	Time difference.....	145
Send while shooting.....	116, 143	Time zone.....	15, 145
Sequence	21, 79	Time zone and date.....	14, 117, 145
Sequence display.....	116, 142	Time-lapse movie 	35, 92
Setup menu	117, 145	TV.....	102, 103
Shooting	17, 32, 88	U	
Shooting menu	112, 115, 118, 120	USB cable.....	11, 102, 104, 108
Shooting mode	33	V	
Short movie show mode.....	33, 95	Vibration reduction	
Shutter sound.....	152	115, 117, 136, 150
Shutter speed	52, 55	ViewNX-i.....	102, 108
Shutter-priority auto mode.....	52	Vividness	46, 56, 62
Shutter-release button	2, 18, 67	Volume.....	98
Single	115, 123	W	
Single AF.....	129, 135	White balance.....	115, 120
Skin softening.....	42, 46, 83	Wi-Fi.....	116, 143
Slide show.....	116, 139	Wind noise reduction	115, 137
Slow motion movies	131, 133	Z	
Slow sync.....	58	Zoom.....	18, 65
Small picture	85, 116	Zoom control.....	18, 65
Smart portrait 	35, 46		
Smile timer	49		
Snap-back zoom button.....	66		
SnapBridge app.....	24		
Snow 	35		
Sound settings.....	117, 152		
Special effects.....	96		



No reproduction in any form of this manual, in whole or in part (except for brief quotation in critical articles or reviews), may be made without written authorization from NIKON CORPORATION.

NIKON CORPORATION

© 2016 Nikon Corporation



FX8E05(11)
6MN67011-05